

# KENWOOD

## DMC-J7R

PORTABLE MINIDISC RECORDER

### INSTRUCTION MANUAL

ENREGISTREUR DE MINI-DISQUE PORTABLE

### MODE D'EMPLOI

KENWOOD CORPORATION

ENGLISH

FRANÇAIS



#### *In regard to the power supply*

Do not use a power source other than the specially provided AC adaptor or the optional battery case or the optional car battery adaptor.

#### *En ce qui concerne l'alimentation*

Ne pas utiliser de source d'alimentation autre que l'adaptateur secteur spécialement fourni, le bloc-batterie en option ou l'adaptateur de batterie de voiture en option.

TINSK0359AFZZ

A9805.1.5MNS.SM

B60-4020-08 (JA) (K/P) (OC)

99/12 11 10 9 8 7 6 5 4 3 2 1 98/12 11 10 9 8 7 6 5 4

***Unpacking***

Unpack the unit carefully and make sure that all accessories are put aside so they will not be lost.

Examine the unit for any possibility of shipping damage. If your unit is damaged or fails to operate, notify your dealer immediately. If your unit was shipped to you directly, notify the shipping company without delay. Only the consignee (the person or company receiving the unit) can file a claim against the carrier for shipping damage.

We recommend that you retain the original carton and packing materials for use should you transport or ship the unit in the future.

Keep this manual handy for future reference.

***WARNING NOTICE:***

IN MOST CASES IT IS AN INFRINGEMENT OF COPYRIGHT TO MAKE COPIES OF TAPES OR DISCS WITHOUT THE PERMISSION OF THE COPYRIGHT OWNERS. ANYONE WISHING TO SHOULD CONTACT THE MECHANICAL COPYRIGHT PROTECTION SOCIETY LIMITED, OR THE PERFORMING RIGHTS SOCIETY LIMITED.

***Before applying power***

AC adaptors are designed for operation as follows:

U.S.A. and Canada ..... AC 120 V only

***Safety precautions***

**WARNING:** TO PREVENT FIRE OR ELECTRIC SHOCK,  
DO NOT EXPOSE THIS APPLIANCE TO  
RAIN OR MOISTURE.

US and foreign patents licensed from Dolby Laboratories Licensing Corporation

***For the U.S.A.*****FCC WARNING**

This equipment may generate or use radio frequency energy. Changes or modifications to this equipment may cause harmful interference unless the modifications are expressly approved in the instruction manual. The user could lose the authority to operate this equipment if an unauthorized change or modification is made.

**NOTE:**

This equipment has been tested and found to comply with the limits for a Class B digital device, pursuant to Part 15 of the FCC Rules. These limits are designed to provide reasonable protection against harmful interference in a residential installation. This equipment may cause harmful interference to radio communications, if it is not installed and used in accordance with the instructions. However, there is no guarantee that interference will not occur in a particular installation. If this equipment does cause harmful interference to radio or television reception, which can be determined by turning the equipment off and on, the user is encouraged to try to correct the interference by one or more of the following measures:

- Reorient or relocate the receiving antenna.
- Increase the separation between the equipment and receiver.
- Connect the equipment into an outlet on a circuit different from that to which the receiver is connected.
- Consult the dealer or an experienced radio/TV technician for help.

***For CANADA*****Canadian IC Compliance Notice**

**NOTICE:** This Class B digital apparatus meets all requirements of the Canadian Interference-Causing Equipment Regulations.

***For the U.S.A.*****CAUTION:**

Use of controls or adjustments or performance of procedures other than those specified herein may result in hazardous radiation exposure.

In compliance with Federal Regulations, following are reproductions of labels on, or inside the product relating to laser product safety.

KENWOOD CORPORATION  
2967-3, ISHIKAWA-CHO,  
HACHIOJI-SHI,  
TOKYO, JAPAN

KENWOOD CORP. CERTIFIES  
THIS EQUIPMENT CONFORMS  
TO DHHS REGULATIONS NO. 21  
CFR 1040.10, CHAPTER I, SUB-  
CHAPTER J.

Location: Bottom Panel

# IMPORTANT SAFEGUARDS

Please read all of the safety and operating instructions before operating this unit. For best results, follow all warnings placed on the unit and adhere to the operating and use instructions. These safety and operating instructions should be retained for future reference.

1. **Power sources** — The unit should be connected to a power supply only of the type described in the operating instructions or as marked on the appliance.
2. **Power-cord protection** — Power-supply cords should be routed so that they are not likely to be walked on or pinched by items placed upon or against them, pay particular attention to cords at plugs, convenience receptacles, and the point where they exit from the unit.
3. **Enclosure removal** — Never remove the enclosure. If the internal parts are touched accidentally, a serious electric shock might occur.
4. **Drop** — Do not drop the unit or apply strong shock to it. (Damage due to dropping the unit is not covered by the warranty.)
5. **Ventilation** — Avoid hindering the ventilation of the unit by covering it with a cloth, etc.
6. **Abnormal smell** — If an abnormal smell or smoke is detected, immediately turn the power OFF and pull out the power cord. Contact your dealer or nearest service center.
7. **Heat** — Avoid placing the unit under direct sunlight or near a source of heat such as heating equipment. Particularly, never leave it in an automobile or on the dashboard.
8. **Temperature** — The unit may not function properly if used at extremely low, or freezing temperatures. The ideal ambient temperature is above +5°C (41°F).
9. **Water and moisture** — The unit should not be used near water — for example, near a bathtub, washbowl, kitchen sink, laundry tub, in a wet basement, or near a swimming pool, etc.
10. **Dust and moisture** — Avoid places where is dusty or where the humidity is high.
11. **Vibrations** — Avoid placing the unit on an unstable place such as a shelf or in a place subject to vibrations.

12. **Magnetic fields** — Keep the unit away from sources of magnetic fields such as TV sets, speaker systems, radios, motorized toys or magnetized objects.
13. **Cleaning** — Do not use volatile solvents such as alcohol, paint thinner, gasoline, or benzine, etc. to clean the cabinet. Use a clean dry cloth.
14. **Nonuse periods** — The power cord of the unit should be unplugged from the outlet when left unused for a long period of time.
15. **Damage requiring service** — The unit should be serviced by qualified service personnel when:
  - A. The power-supply cord or the plug has been damaged.
  - B. Objects have fallen, or liquid has been spilled into the unit.
  - C. The unit has been exposed to rain.
  - D. The unit does not appear to operate normally or exhibits a marked change in performance.
  - E. The unit has been dropped, or the enclosure damaged.
16. **Servicing** — The user should not attempt to service the unit beyond that described in the operating instructions. All other servicing should be referred to qualified service personnel.
17. **CAUTION** — TO PREVENT ELECTRIC SHOCK DO NOT USE THE AC PLUG WITH AN EXTENSION CORD, RECEPTACLE OR OTHER OUTLET UNLESS THE BLADES CAN BE FULLY INSERTED TO PREVENT BLADE EXPOSURE.

**The marking of products using lasers  
(Except for some areas).**

**CLASS 1  
LASER PRODUCT**

This label is attached to the bottom panel and says that the component uses laser beams that have been classified as Class 1. It means that the unit is utilizing laser beams that are of a weaker class. There is no danger of hazardous radiation outside the unit.

***REQUIREMENT BY NEDERLAND GAZETTE***

Batteries are supplied with this product. When they are empty, you should not throw them away. Instead, hand them in as small chemical waste.

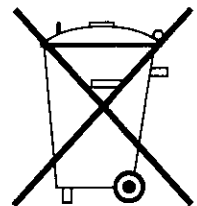

## INTRODUCTION

Thank you for purchasing this KENWOOD product.  
For the best performance, read this manual carefully.  
It will guide you in operating your KENWOOD product.

## CONTENTS

	Page		Page
ACCESSORIES .....	5	ABOUT THE TOC .....	23
PRECAUTIONS .....	6-7	PLAYING A MINIDISC .....	24-25
NAMES OF CONTROLS AND		CONVENIENT PLAYBACK	
INDICATORS .....	7-8	FUNCTIONS .....	26-28
POWER SOURCE .....	9-10	EDITING .....	29-34
BEFORE RECORDING .....	11-12	USING WITH OTHER EQUIPMENT ....	35
RECORDING USING THE CABLE		CONVENIENT OPERATION	
INCLUDED WITH THE UNIT .....	13-14	FEATURES .....	36-38
RECORDING USING AN OPTIONALLY		WHAT IS A MINIDISC? .....	39
AVAILABLE DIGITAL CABLE .....	15	TROUBLESHOOTING .....	39-40
RECORDING USING A		MINIDISC SYSTEM LIMITATIONS.....	41
MICROPHONE .....	16-17	ERROR MESSAGES .....	42
CONVENIENT RECORDING		MAINTENANCE .....	43
FUNCTION .....	18-21	SPECIFICATIONS.....	43-44
ABOUT TRACK NUMBERS .....	22		

## ACCESSORIES

- Headphones x 1
- Remote Control Unit x 1
- AC Adaptor x 1
- Rechargeable Lithium-Ion Battery (NB-L10A) x 1
- RCA Lead x 1
- Carrying Bag x 1

### Note:

Parts and equipment mentioned in this operation manual other than those detailed above are not included.

# PRECAUTIONS

## ■ Important

- Do not wear your headphones when you are crossing streets or near traffic.
- Do not use your headphones while driving a motor vehicle, it may create a dangerous traffic hazard and may be illegal. Remember to obey all of the safety rules in your area.
- Do not play the unit at a high volume. Hearing experts advise against extended play at high volume levels.
- If you experience ringing in your ears, reduce the volume or discontinue use.

## ■ Volume setting

If the volume is adjusted according to your usual expectations of noise, you may damage your hearing due to the high volume. Reduce the volume before starting to play. MiniDiscs, compared to ordinary cassette tapes, have very little noise.

## ■ Concern for others when listening to MiniDiscs

While listening to music, the sound escaping from your headphones may disturb people around you.

If you are using the unit in particularly crowded places (such as on trains or buses), reduce the volume to avoid disturbing people around you.

## ■ Storing the unit

### **Avoid using or leaving the unit in the following places.**

- Places exposed to direct sunlight for many hours (especially in cars with the doors and windows closed) or near heaters.  
(The cabinet may deform, change color, or malfunction.)
- Places exposed to water.
- Places exposed to excessive dust.
- Places where temperatures are excessively high or low.
- Places (bathrooms) where the humidity is extremely high.
- Places with strong magnetic fields such as TVs or loudspeakers.
- Places exposed to vibration.
- Places where sand can easily enter the inside of the unit (beaches etc.).
- If the unit is used near radio tuners or TVs, noise and/or picture interference may result. If you experience these problems, move the unit away from such devices.

## ■ Precautions

### **To avoid accidental electric shock or other possible problems, observe the precautions listed below.**

- Do not disassemble or modify the unit.
- Do not drop or subject the unit to shock.
- Do not use the unit near open flames.
- Do not spill liquid on the unit.
- Do not use an external power supply, other than the 5V DC power supply packaged with this unit.
- KENWOOD is not responsible for damage due to improper use. Refer all servicing to a KENWOOD authorized service center.

## ■ Notes about the rechargeable battery

- A rechargeable lithium-ion battery is the only kind that can be used. Even if the battery supplied with the unit is not used, you should charge it at least once every three months to maintain the battery.
- The rechargeable battery can be charged approximately 300 times.
- Do not use any battery other than that specified. Use of other batteries may cause malfunctions.
- When the operating time is reduced to about half the normal amount of time, even after a full charge is performed, replace the battery with a new one.
- When charging or when using the rechargeable battery, use it within an ambient temperature range of 41°F (5°C) to 95°F (35°C).
- If the rechargeable battery is used in a cold environment, the operating time will decrease.

**Since the rechargeable battery is vulnerable to damage, please note the following.**

- Do not carry the battery in your pocket or in a bag together with metal objects (keys, coins, jewelry, etc.). The battery may short out and generate significant amounts of heat.
- Do not short-circuit the terminals as they will become very hot and will damage the battery.
- Do not dip the battery in water, do not dispose of it in a fire, and do not take it apart.

**To avoid damaging the battery and shortening its service life, please note the following.**

- Do not drop or subject the battery to shock.
- Do not insert objects (metal etc.) into the battery compartment of this product or into the rechargeable battery. Do not get the terminals dirty. If the rechargeable terminals are dirty, the operating time may be shortened or it may not be possible to charge the battery.
- After the rechargeable battery is charged or used, it will get slightly warm. This is normal.

## NAMES OF CONTROLS AND INDICATORS

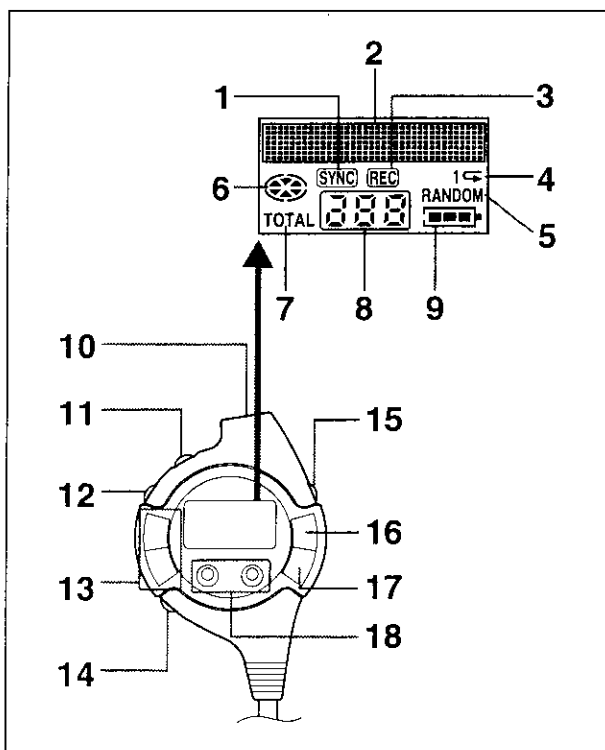





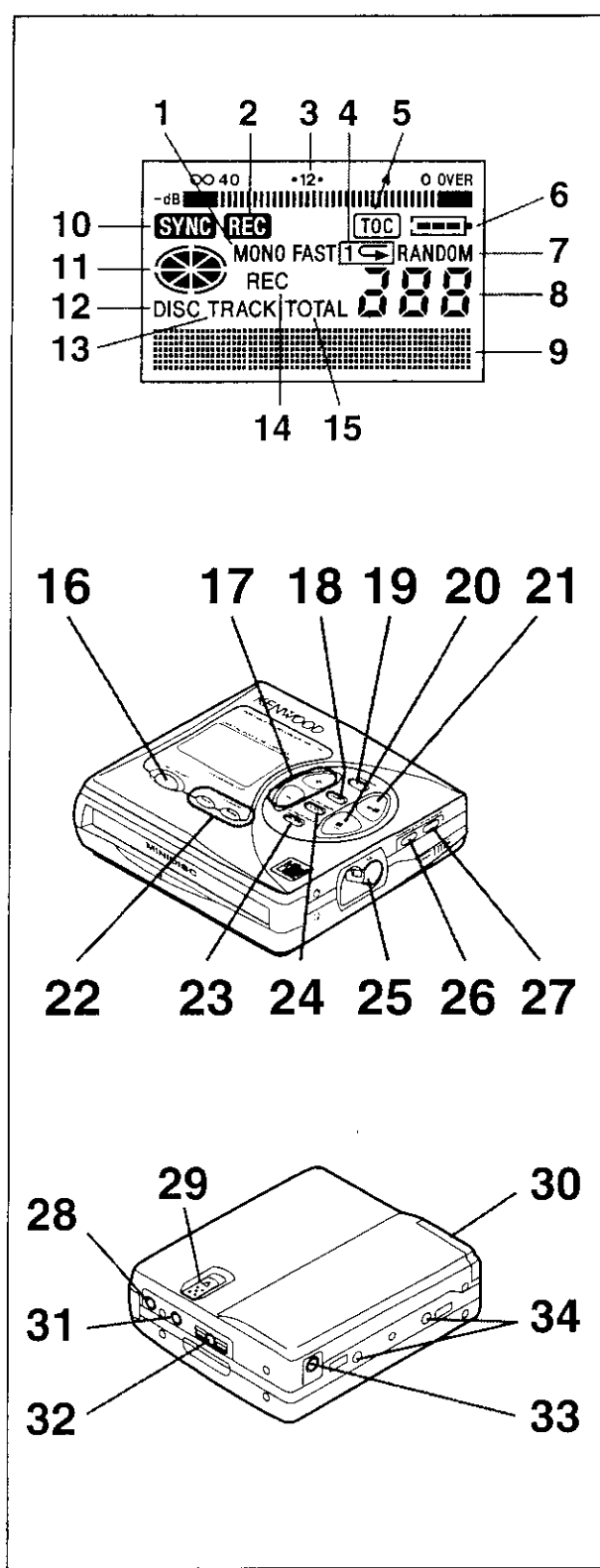

### ■ Remote control unit

1. Synchro Recording Indicator
2. Character/Time Information Indicator
3. Record Indicator
4. Repeat Indicator:
5. Random Indicator
6. Disc Mode Indicator
7. Total Track Number Display
8. Track Number Indicator
9. Battery Indicator:
10. Headphones Jack
11. Hold Switch
12. Play Mode Button
13. Volume Buttons: +, -
14. Bass Button
15. Display Button
16. Play/Pause Button:
17. Stop/Power Off Button:
18. Fast Reverse/Fast Forward Buttons:





## ■ Main unit

1. Monaural Long-Play Mode Indicator
2. Record Indicator
3. Level Meter
4. Repeat Indicator: 
5. TOC Indicator
6. Battery Indicator: 
7. Random Indicator
8. Track Number Indicator
9. Character/Time Information Indicator
10. Synchro Recording Indicator
11. Disc Mode Indicator
12. Disc Name Indicator
13. Track Name Indicator
14. Remaining Recording Time Indicator
15. Total Track Number Display
16. Record/Track Mark Button
17. Volume/Name Select Buttons: +, -
18. Display/Lowcase Characters Button
19. Character Button
20. Stop/Power Off/Charge Button:  / OFF
21. Play/Pause Button: 
22. Fast Reverse/Fast Forward/Recording Level Control/Cursor Buttons:  / 
23. Enter/Fast Play/Synchro Button
24. Edit/Auto Mark/Time Mark Button
25. Eject Lever
26. Bass/Delete Button
27. Mode/Insert Button
28. Microphone Input Jack
29. Hold Switch
30. Rechargeable Lithium-Ion Battery Compartment
31. Optical/Line Input Jack
32. Headphones Jack
33. 5V DC Input Jack
34. Battery Case Connection Terminals

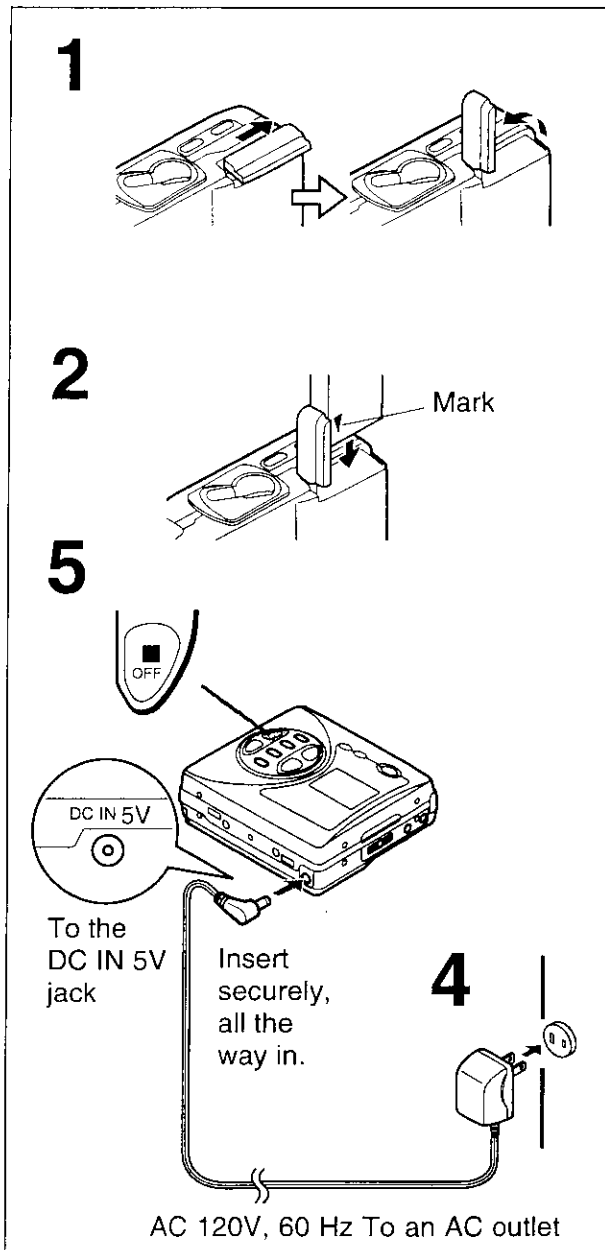

## POWER SOURCE

This unit can be used with 4 different power sources: a rechargeable battery, an AC adaptor, an optionally available battery case, and an optionally available car adaptor (DC-C70).



### ■ Rechargeable battery power

When the rechargeable battery is used for the first time or when you want to use it after a long period of non use, be sure to charge it fully.

- 1** Open the rechargeable battery compartment cover.
- 2** Insert the rechargeable battery.
  - Insert the side with the arrow first.
- 3** Close the rechargeable battery compartment cover.
- 4** Plug the AC adaptor into the AC outlet, and then insert the plug on the AC adaptor cord into the DC IN 5V jack.
- 5** Press the ■ / OFF button twice to begin charging.
  - “” will appear, and the battery will begin charging.
  - Battery charging will be complete in 3.0 hours. When the charging is complete, “” will go out.

#### Notes:

- After charging is complete, the AC adaptor may be left connected. (For example, when charging at night)
- The battery will not be charged whenever the power to the main unit is turned on.
- If the AC adaptor is removed from the main unit or from the AC outlet while charging, “” will not disappear for about 1 minute. This is normal.
- Do not force open the rechargeable battery door too far.
- Do not attach the optionally available battery case when charging the internal battery.

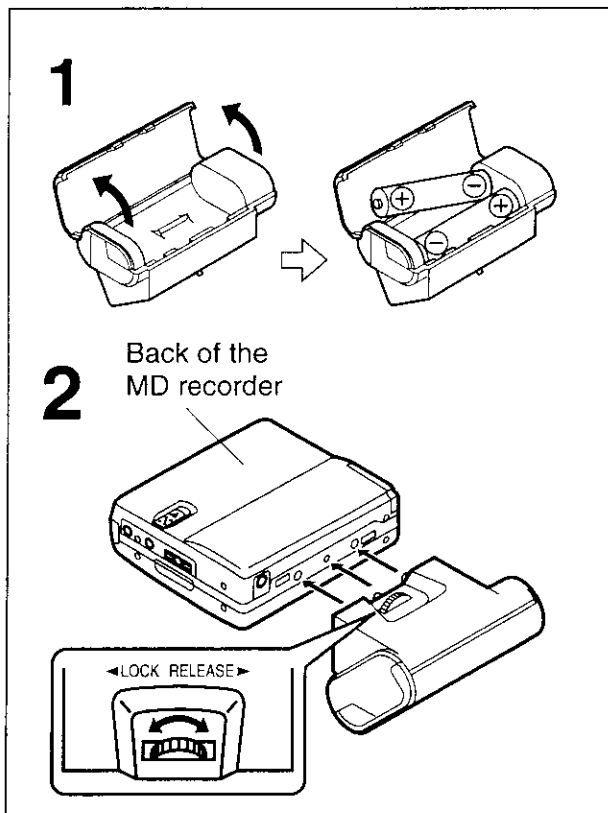

#### Cautions:

- When using the rechargeable battery and the alkaline batteries at the same time, do not remove either of them. If you do, while the unit is in the play mode, playback will stop. When in the recording mode, the recorded contents will be erased, and the power may be disconnected.
- Do not replace the batteries or the rechargeable battery during operation.
- Do not use rechargeable batteries (nickel-cadmium battery etc.) in the battery case.
- If the unit will not be used for a long period of time, remove the batteries. (Even if the power is turned off, the batteries will drain slowly but continuously.)
- Be sure to hold the plug when removing it. If you pull on the cord, it may break, or the unit may malfunction.
- Do not use any car adaptor except for the optionally available DC-C70.
- For information about battery life, see the battery section in the SPECIFICATIONS on page 43.
- This unit should only be used within the range of 32°F (0°C) and 104°F (40°C).

#### ■ Alkaline battery power

Use of the optionally available alkaline battery case combined with the rechargeable battery will result in extended playback times.

- Use two, commercially available alkaline batteries (LR6, "AA" size).

**1** Insert the batteries into the battery case.

- (1) Open the case cover.
- (2) Insert the batteries according to the polarity marked on the inside of the battery case. Then, close the case cover.

**2** Attach the battery case to the main unit.

- (1) Match the convex part of the battery case to the concave area in the main unit.
- (2) Turn the screw in the direction marked "LOCK" to secure the battery case.

#### Note:

- The battery case is only sold in certain areas. For more details, please ask your dealer.

#### ■ AC power

Plug the AC adaptor into the AC outlet, and then insert the plug on the AC adaptor cord into the DC IN 5V jack.

#### Notes:

- If there is an electrical storm in your vicinity, unplug the AC adaptor from the AC outlet.
- When the unit is not in use for extended periods, remove the AC adaptor from the AC outlet.
- Never use an AC adaptor other than the one specified. Otherwise, malfunctions or serious safety hazards may result.
- Do not bend, twist or tie the power cord or put heavy objects on top of it.

# BEFORE RECORDING

## ■ Type of recording

Two types of recording are possible: "Digital recording" and "Analog recording". There are different cables and connections for each type of recording, depending on the jacks on the equipment being connected to the unit.

### (1) Analog recording

Connect the unit to equipment that has a line output jack, using the cable included with this unit.

- Main equipment: CD player, MD player, radio cassette player, etc.
- Cable required: Connecting cable included with this unit

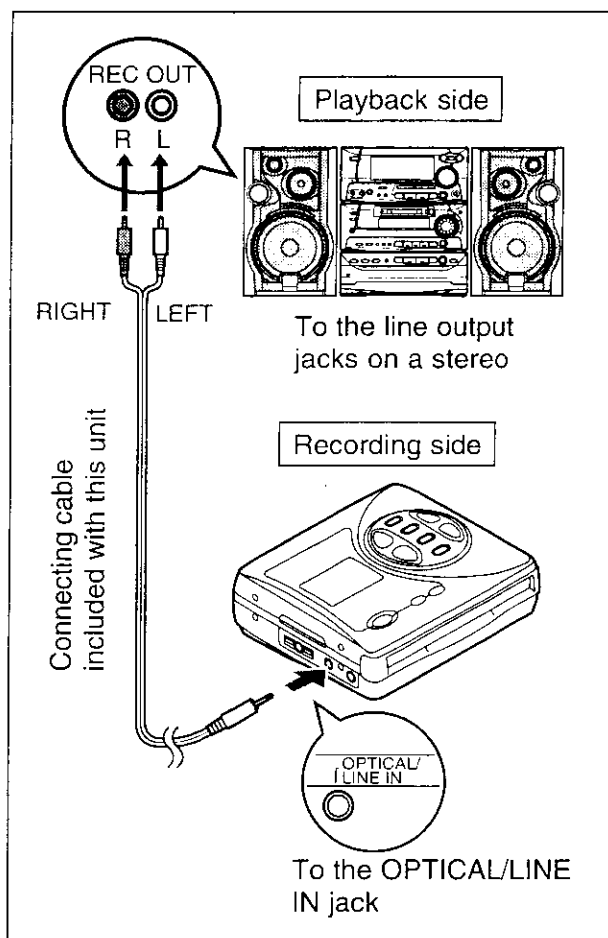

### (2) Digital recording

Connect the unit to equipment that has an optical output jack using an optical digital cable (available optionally). Using an optical signal to transfer the music to a MiniDisc allows very high quality recording.

- Main equipment: DSS tuner, CD player, MD player, etc.
- Cable required: Optical digital cable

#### Note:

- The optical digital cable is only sold in certain areas. For more details, please ask your dealer.

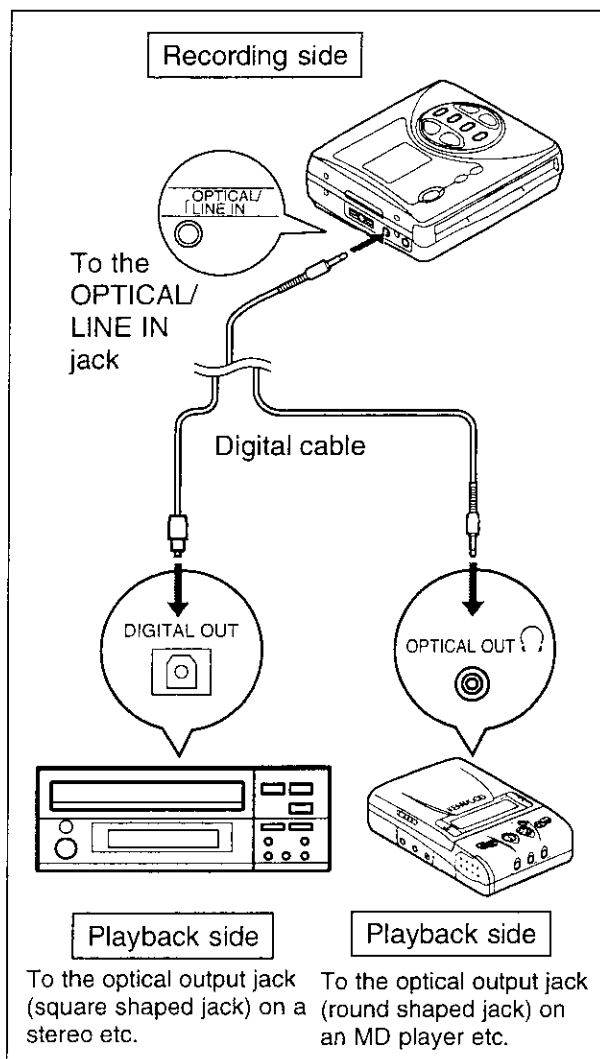

## ■ Types of discs

There are two types of discs: playback-only and recordable discs.

### ● Playback-only MiniDisc:

This type of MiniDisc usually contains commercially available pre-recorded music. This is the same kind of optical disc as CDs. Playback is performed using an optical pickup.

(Recording and editing are not possible.)

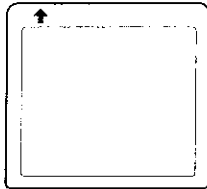

There will only be a shutter on one side (the back).

### ● Recordable MiniDisc:

This is a "raw disc" on which recording can be performed. This is a magneto-optical disc.

Recordings are made using a laser and a modulated magnetic field. Repeated recording is possible.

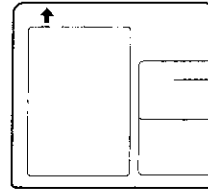

Shutters can be seen on both sides of this type of disc.

## ■ To prevent recorded discs from being erased accidentally

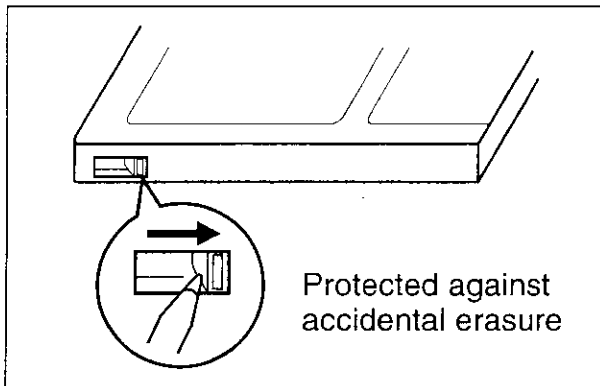

Slide the accidental erase prevention tab, located on the side of the disc, in the direction indicated by the arrow.

- The disc will then be protected against accidental erasure.
- To add a recording to such a disc, slide the accidental erase prevention tab back to its original position.

### Notes:

- When making important recordings, it is recommended that you use the AC adaptor. A fully charged rechargeable battery should be loaded into the unit. Then, even if a power failure occurs, the power source will switch over to the rechargeable battery automatically.
- When using the rechargeable battery or the alkaline batteries, if the headphones volume level is set to "0", the battery consumption will be less than when listening to the recording while it is being made.
- Insert each plug firmly. If the connections are poor, the recording may not be made properly. Always keep the plugs clean. If the plugs are dirty, electrical noise may be recorded.

# RECORDING USING THE CABLE INCLUDED WITH THE UNIT

## ■ Recording from CDs or MDs (Synchro recording)

- Synchro recording is a method that detects the playback sound from the source equipment. When sound is present, it automatically starts the recording. When the source is silent, the recording will be paused.

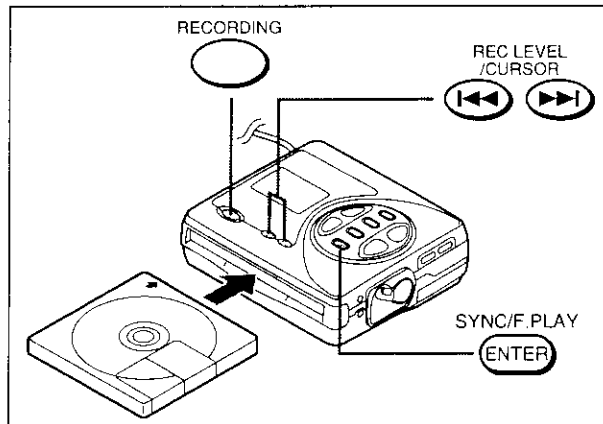

- 1** Connect the external equipment. (See page 11.)
- 2** Insert a recordable MiniDisc.
- 3** Press the RECORDING button.
  - To record from a tuner, first tune in a broadcast.
  - To record from a CD, first start playing the track you want to record.
- 4** While playing sound from the external equipment connected to this unit, press the **◀◀** or **▶▶** button to adjust the recording level.

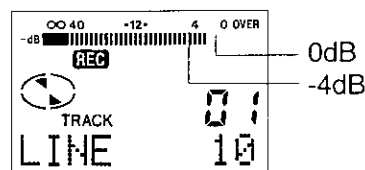

- Adjust the recording level so that the maximum sound volume from the source makes the reading swing somewhere between -4 dB and 0 dB.
- To record from a CD, first adjust the recording level. Then put the equipment connected to this unit into the playback stand-by mode.

- 5** Press the ENTER/SYNC/F.PLAY button.

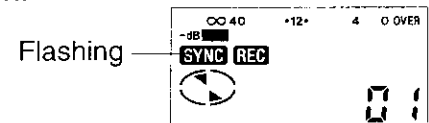

- 6** Begin playback on the source equipment.
  - Recording will begin automatically.

### To interrupt recording:

- When the source equipment is stopped, the unit will enter the synchro recording stand-by mode. When playback is resumed, a recording will be resumed.
- If a silence lasts for 3 seconds or more, the recording will be paused.
- Pressing the **▶||** button on this unit (when in this mode) will cause the unit to enter the recording stand-by mode and cancel the synchro recording mode.

### To stop recording:

Press the ■ / OFF button.

- If the unit is left alone after the recording has stopped, the power will be turned off about 2 minutes later.

### After recording:

Press the ■ / OFF button while in the stop mode.

- After the track number has been written on the disc, the power will be turned off

automatically. (For details about the TOC, see page 23.)

### To remove the MiniDisc:

Turn off the power and move the EJECT lever in the direction indicated by the arrow.

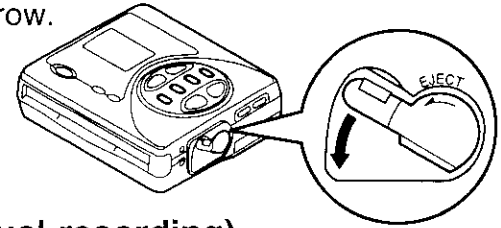

## ■ Recording from a tuner or a CD (Manual recording)

- Manual recordings can be started and stopped as you like.

**1** Put the unit in the recording stand-by mode. (Perform steps 1 - 4 in the "Synchro recording" section.)

**2** Press the ►|| button.

- Recording will start.
- To record from a CD, press the ►|| button, and then start playback on the equipment connected to this unit.
- Track numbers can be created while recording. (Page 20)

### To interrupt recording:

Press the ►|| button while recording.

- The unit will enter the recording stand-by mode.
  - To resume recording, press the ►|| button again.
- The track number will be increased by one each time you interrupt a recording.

### Recordings can not be made in the following situations:

- Recording on a playback-only MiniDisc (commercially available music)
- If a Minidisc is protected against accidental erasure (page 12)

### About the recording level:

- If the recording level is too low, the playback sound volume may be too low to hear well. If it is too high, the playback sound may be greatly distorted. Since digitally recorded CDs have a large dynamic range (the volume can vary tremendously from very soft to extremely loud), do not set the recording level any higher than is necessary.

### Precautions when recording:

- Do not jar or bump the main unit while recording. Otherwise, the recording may be unusable.

- Depending on the strength and type of playback signal in the original recording, the new recording may not begin or pause at the correct point when in the synchro mode. If this happens, try making a manual recording.

### Precautions when inserting a MiniDisc:

- To insert a Minidisc, push on the middle of the edge of the disc while holding it parallel to the main unit.
- If any resistance is felt, do not try to force the MiniDisc into the unit. It may cause more problems. If resistance is felt, remove the MiniDisc and try reloading it.

### Notes:

- Whenever any button is pressed, the remote control display will light for about 4 seconds.
- The RECORDING button does not light.

# RECORDING USING AN OPTIONALLY AVAILABLE DIGITAL CABLE

This is the method used to record digital signals from CDs or MDs exactly as they are stored on the original. Compared to recordings made from analog inputs, digital recordings have extremely high-quality sound.

**1** Connect the external equipment.  
(See page 11.)

**2** Start recording.  
**Synchro recording: Page 13**

Before starting a synchro recording, perform the following steps on the equipment connected to this unit.

- (1) First, put it in the playback mode.
- (2) Next, put it in the pause mode.
- (3) Finally, position it at the beginning of the track you want to record.

- (1) Insert a recordable MiniDisc, and then press the RECORDING button.
- (2) Press the ENTER/SYNC/F.PLAY button.
- (3) Start the playback on the equipment connected to this unit.

### Manual recording: Page 14

- (1) Insert a recordable MiniDisc, and then press the RECORDING button.
- (2) Press the ►|| button.

- When recording from digital inputs, it is not necessary to adjust the recording level.

### There are cases where digital recording may be impossible.

In the following cases digital recording is impossible, even if you are using digital cables.

When you attempt to make a new digital recording from a track that was digitally recorded on a MiniDisc

- MiniDiscs are designed so that only first generation digital copies can be made, further digital copies are prevented by the SCMS (Serial Copy Management System).

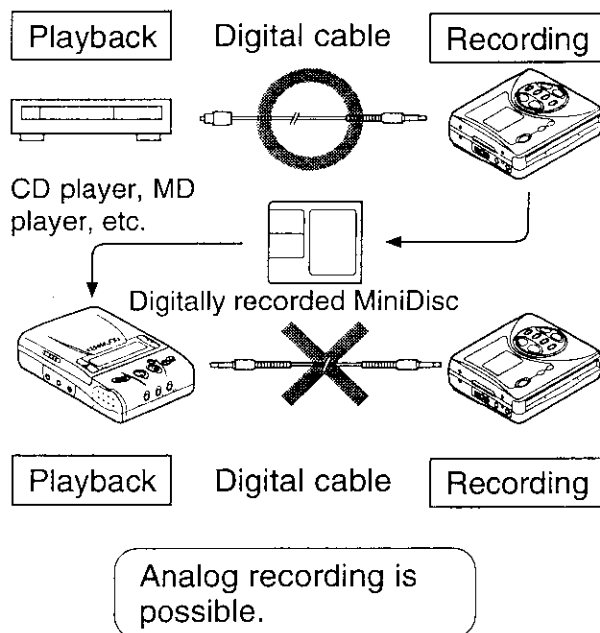

### Notes:

- This unit incorporates a sampling rate converter. When this unit is connected to digital equipment such as DSS tuners or DAT tape recorders that use a different sampling frequency (32 kHz or 48 kHz), recordings can still be made. (The sampling frequency of this unit is 44.1 kHz.)
- When making a digital recording from a portable CD player (if the player has a sound skip prevention function and this function is turned on) the optical output will drop out and digital recording will not be possible. Be sure to turn the sound skip prevention function off.



# RECORDING USING A MICROPHONE

## ■ Recording from the microphone (Mic synchro recording)

The recording will begin automatically in response to a noise or a person speaking. When the sound stops, the recording will pause. This function is convenient when recording lectures, conferences, etc.

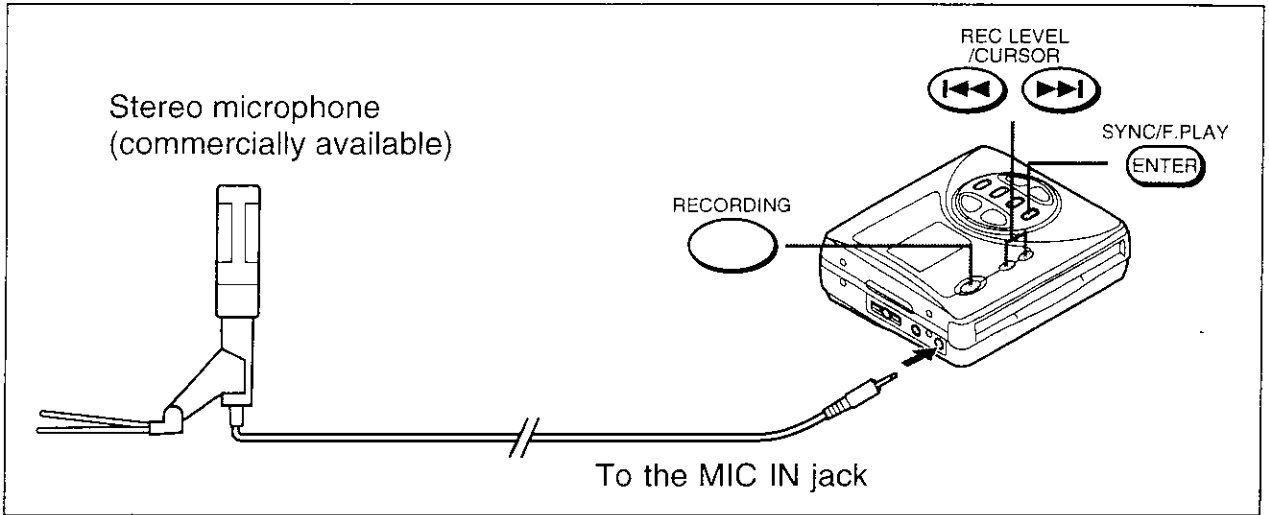

- 1** Connect the stereo microphone to the MIC IN jack on the main unit.
  - When a microphone is connected to this unit, the unit will automatically switch to input from the microphone.
- 2** Insert a recordable Minidisc.
- 3** Press the RECORDING button.
  - A monaural, long-play recording mode is available. (Page 20)
  - Timed identification marks can be created while recording. (Page 18)
- 4** Press the ◀◀ or ▶▶ button to adjust the recording level.

- 5** Press the ENTER/SYNC/F.PLAY button to select the synchro recording level. (This level can be changed, even while recording.)
  - Refer to the following table.

	Synchro recording level display	Sound level at which to start recording
Mic input	<b>MIC SYNC H</b>	 -24dB
	<b>MIC SYNC L</b>	 -12dB

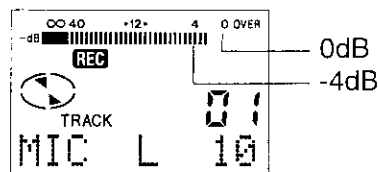

- Adjust the recording level so that the maximum sound volume from the source makes the reading swing between -4 dB and 0 dB.
- When the recording level display is changed from "MIC H" to "MIC L", the sound will be interrupted momentarily. This is normal.

- When the microphone input is set to MIC SYNC H, recording will start when a sound is detected at the lowest volume. If the unit starts recording too often due to low, unwanted noises, set the microphone input to MIC SYNC L.

- 6** When a sound, such as a person speaking, is picked up by the microphone, recording will begin automatically.
- If a silence lasts for 3 seconds or more, the recording will be paused automatically. However, the unit will not pause for about the first 10 seconds after recording has started.

**To interrupt a synchro recording:**

Press the ►|| button while recording.

- The Mic synchro recording mode will be canceled, and the unit will enter the recording stand-by mode.
- To resume synchro recording, press the ENTER/SYNC/F.PLAY button again.

**To stop recording:**

Press the ■ / OFF button.

**■ Recording from the microphone**

**(Mic manual recording)**

- You can start recording manually (any time you like).

**1** Put the unit in the recording stand-by mode. (Perform steps 1 - 4 in the “Mic synchro recording” section.)

**2** Press the ►|| button.  
● Recording will start.

**To interrupt a recording:**

Press the ►|| button while recording.

- The unit will enter the recording stand-by mode.
- To resume recording, press the ►|| button again.

The track number will be increased by one each time you interrupt a recording.

**To stop recording:**

Press the ■ / OFF button.

**Notes:**

- If you want to use a microphone, be sure it is a plug-in power type microphone that can be powered by the main unit.
- Insert the plug firmly. Otherwise, the recording will not be made properly.
- Use a microphone with a 1/8" (3.5 mm) diameter stereo mini plug.
- When a recording is made using a stereo microphone (optionally available), an analog recording will be made.
- While making a mic recording, do not connect anything to the LINE IN jack on the main unit.
- The microphone is only sold in certain areas. For more details, please ask your dealer.

# CONVENIENT RECORDING FUNCTION

## ■ Creating marks while making a mic recording

### (Timed auto mark function)

Marks can be created at a fixed interval (every 5 minutes is the default setting) so that the beginning of any track can be found. The interval at which marks are created can be changed by the user.

While in the recording stand-by mode or while recording, press the EDIT/AUTO MARK button.

- Each time the button is pressed, the setting will change as follows:

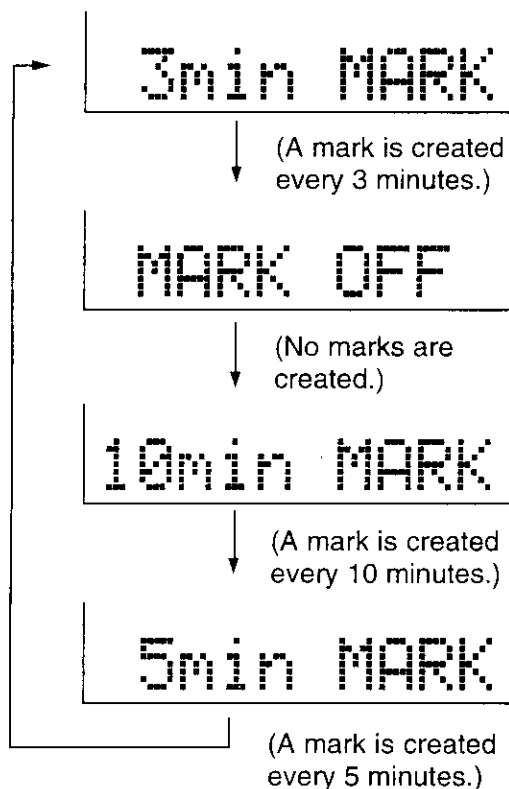

- The time between marks may vary slightly when compared with the actual recording time.

### About the timed auto mark:

Whenever a recording begins, a track number will be created automatically.

- : Track number which is created when a silence lasts for 3 seconds or more during synchro recording.
- : Track number which is created by the timed auto mark function.

Example when the setting is for "5 minutes":

#### When making a mic synchro recording

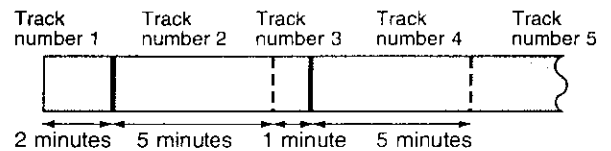

#### When making a mic manual recording

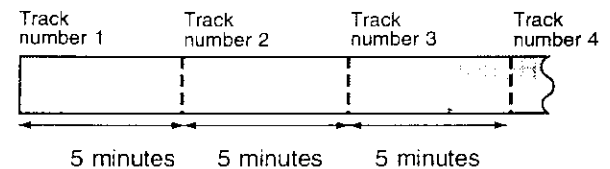

- A timed auto mark will be created every 5 minutes.

#### When the timed auto mark setting has been changed

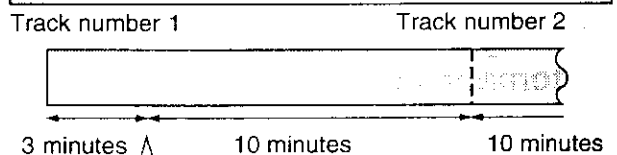

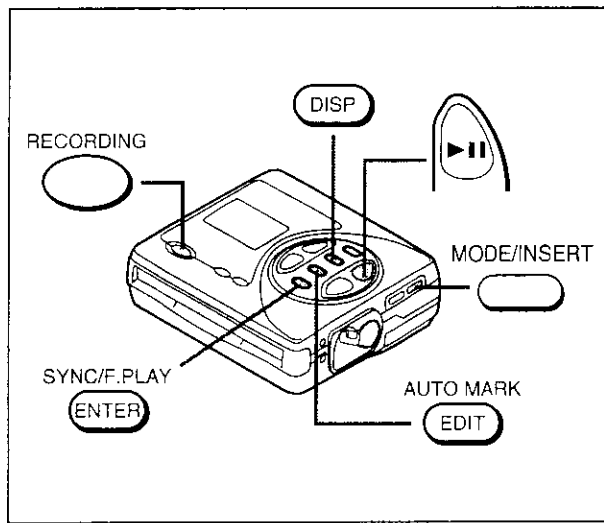

### ■ Recording tracks as a single track

You can record several pieces of music as a single track, disable the auto marker function.

- 1 Press the EDIT/AUTO MARK button while the recording is paused.

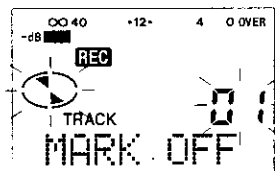

(The display will be blanked out immediately.)

- 2 Press the ►|| button.
  - Recording will start.

**Note:**

- When making digital recordings using a CD player or an MD player, track numbers will be created automatically regardless of the setting of the auto marker function.

### **Making a track number automatically:**

Press the EDIT/AUTO MARK button while the recording is paused.

- "AUTO MARK" will be displayed.

### ■ To start recording from the middle of an existing track

You can erase a portion of a track that has been already recorded and make a new recording.

**Warning:**

- All of the tracks that follow the newly recorded track will be erased.

- 1 During playback, press the ►|| button at the point where you want to begin re-recording.
- 2 Press the RECORDING button.
  - To cancel the operation, press the ■ / OFF button.
- 3 Press the ENTER/SYNC/F.PLAY button.
  - All of the tracks and track names will be erased, following the point where the playback is paused.

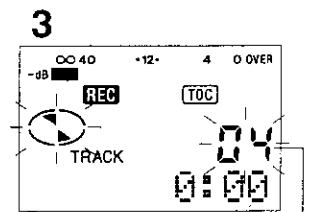
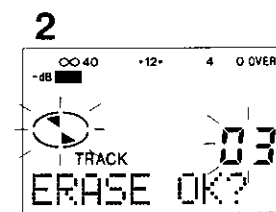

Number of the track to be recorded next

- 4 Press the ►|| button.
  - Recording will start.

**Note:**

- When there is a track that you don't want to erase after the point on the disc where you want to make a new recording, use the move function to move the track and then make your recording after that point.

## ■ To check the remaining disc time

While recording, you can check the remaining time available on the disc.

Press the DISP button while recording or while in the recording pause mode.

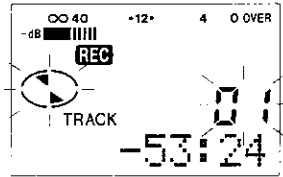

Remaining recordable time

- When the DISP button is pressed again, the unit will return to the initial display.

### **Note:**

- The display of the remaining disc time may vary slightly from the actual remaining time. (Page 41)

## ■ To create your own track numbers while recording

You can create your own track numbers at special points in a recording, so that these points can easily be found later.

At any point where you want to create a track number while recording, press the RECORDING button on the main unit or the BASS button on the remote control unit.

- The track number will be written on the disc and the recording will continue uninterrupted.

## ■ Double time recording in monaural mode

When recording in the monaural long-play mode, recordings will be approximately twice as long as the recording time available for a stereo recording. The monaural long-play mode is very useful for recording conferences or lectures.

Press the MODE/INSERT button while the recording is paused.

- Each time this button is pressed, the display will switch between the stereo mode and the monaural long-play mode.

Lights up while in the monaural long-play mode.

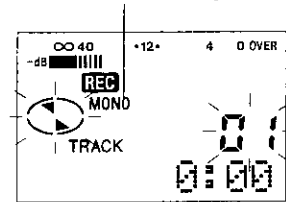

### **Notes:**

- If input is from a stereo source, the sounds from the left and right channels will be combined.
- Although the monitor sound you hear in the headphones while recording is in stereo, recording will be monaural.
- MiniDiscs recorded in the monaural long-play mode cannot be played on other MD players.
- When a recording is made in the monaural long-play mode, you will be able to play back the MiniDisc twice as fast as the normal playback speed. (Page 27)
- When the unit is stopped after a recording has been made in the monaural long-play mode, the recording mode will return to the stereo mode automatically.

## ■ To erase tracks

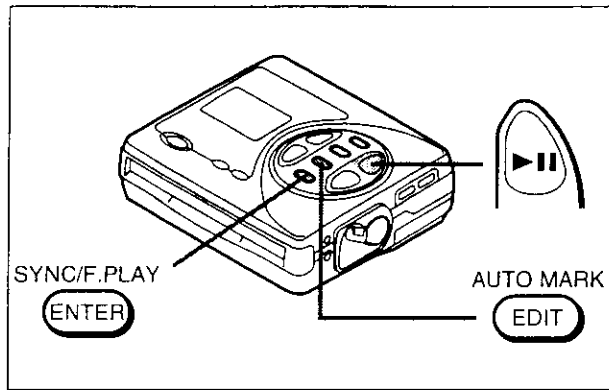

### To erase tracks one at a time:

- 1** Start playing the track you want to erase, and press the ►|| button.
  - The unit will enter the pause mode.
- 2** Press the EDIT/AUTO MARK button to select "ERASE".

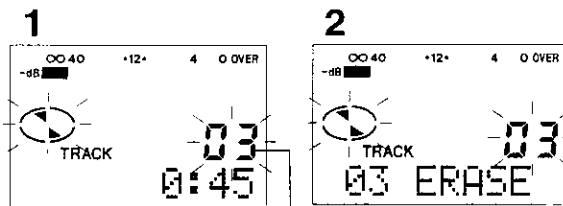

Number of the paused track

- 3** Press the ENTER/SYNC/F.PLAY button.
  - To cancel the operation, press the ■ / OFF button.
- 4** Press the ENTER/SYNC/F.PLAY button again.
  - The track will be erased.

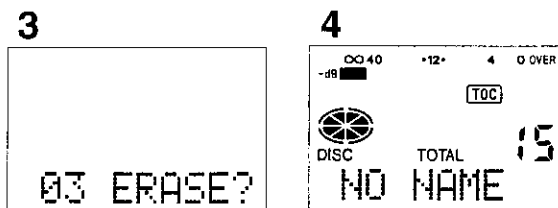

- 5** To erase other tracks, repeat steps 1 - 4.

### To erase all of the tracks at once:

- 1** While in the stop mode, press the EDIT/AUTO MARK button to select "ALL ERASE".
  - "ALL ERASE" can also be selected by holding down the EDIT/AUTO MARK button for at least 2 seconds.
- 2** Press the ENTER/SYNC/F.PLAY button.
  - To cancel the operation, press the ■ / OFF button.

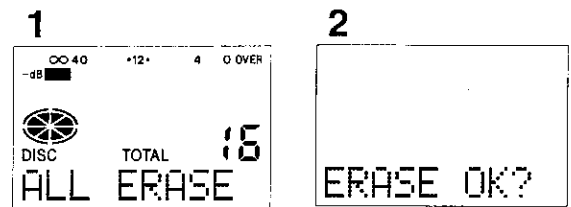

- 3** Press the ENTER/SYNC/F.PLAY button again.
  - All of the track numbers, track names, and disc names will be erased.

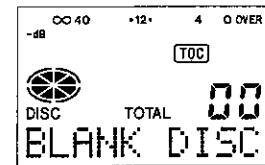

### Notes:

- Once a track has been erased, it cannot be recovered. Double-check the track number before erasing it.
- When a track is erased, the numbers assigned to the tracks following the erased track will be automatically decreased by one.
- When a track is erased, the track name will be erased at the same time.

## ABOUT TRACK NUMBERS

When recording, track numbers will be created automatically.  
(Auto marker function/Synchro marker function)

### When recording from analog inputs: (Including digital inputs other than CDs or MiniDiscs)

A new track number will be automatically created whenever 1 second or more of silence occurs in the source.

(Auto marker function)

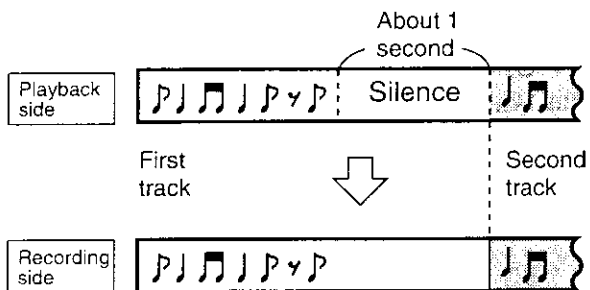

- If there is some noise in the “silent” spaces from the source, the track numbers may not be created at the correct position, depending on the contents of the source being recorded.
- You can also record a series of tracks without using the auto marker function.

### When recording from digital inputs: (CDs/MiniDiscs only)

Track numbers will be created automatically for each track at the same point where track numbers already exist on the CD or MiniDisc.

(Synchro marker function)

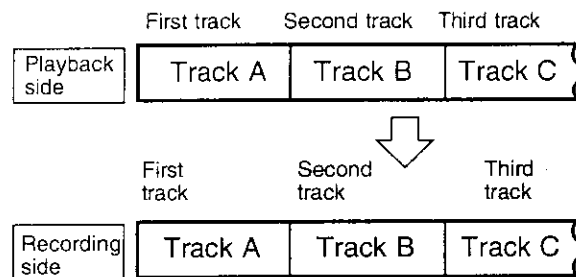

- The track numbers on the playback side may not match the track numbers recorded on the MiniDisc.
- When recording, if a programmed playback is performed by the source or playback is performed by selecting tracks manually, the MiniDisc track numbers may not be the same as on the source.
- The track numbers can also be changed after recording.
- Track numbers may not be created, even when recording from digital inputs, depending on the CD player used for the source.

## ABOUT THE TOC

The TOC (an abbreviation for Table of Contents) is information about the track numbers and recorded areas that allow the unit to find musical selections or sounds. The entire MD is controlled by the information in this TOC, which enables the unit to find the beginning of a track quickly or to record automatically in a vacant area.

- The TOC is recorded in a specific area on a MiniDisc, which is not used for sound recording.

### ■ About TOC recording

When you start recording or editing, "TOC" will appear in the display.

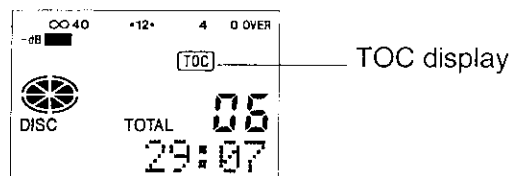

This indicates that information in the TOC is now being changed according to recording or editing being performed.

- **The changed TOC information will not be recorded on the MiniDisc right away.**

#### Notes:

- While "TOC" is displayed, the MiniDisc should not be removed. Turn the power off first, and then remove the MiniDisc.
- The edited contents can be stored on the disc after several editing steps have been performed.

### ■ When is the TOC recorded?

The revised TOC will be recorded on the disc automatically when you press the ■ / OFF button while in the stop mode. This will also turn the power to this unit off.

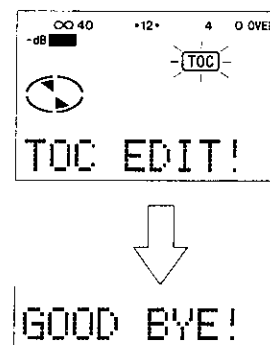

The power will be turned off after the TOC has been recorded on the disc.

#### Cautions:

- While "TOC" or "TOC EDIT!" is displayed, do not do any of the following.
  - Do not jar or bump the main unit.
  - Do not unplug the AC adaptor.
  - Do not remove the rechargeable battery or battery case.If you do, the changes in the recorded or edited contents will be lost if the TOC information is not recorded properly.
- If the AC adaptor is unplugged or a power failure occurs while recording (before the TOC information has been written on the disc), the new recording will be erased.

When a new recording is added to a MiniDisc in a position where TOC information already exists, the added recording will be erased.



# PLAYING A MINIDISC

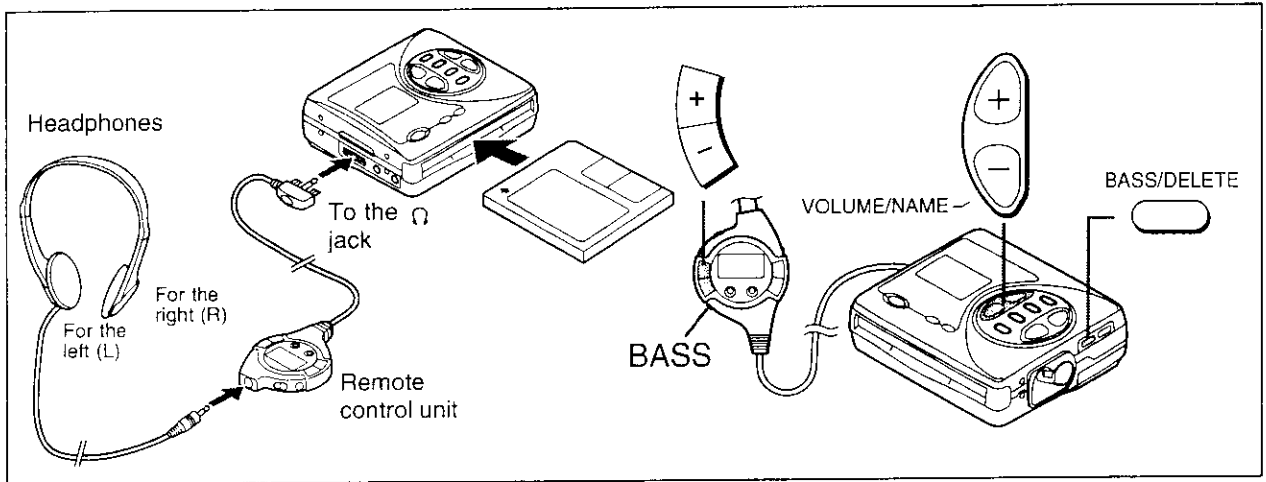

- 1** Insert the headphones plug firmly into the headphones jack on the remote control unit.
- 2** Plug the remote control unit into the  $\Omega$  jack on the main unit. Push the plug all the way in.
  - Since the remote control unit plug has only one correct orientation, plug it in as shown in the drawing.
- 3** Load a MiniDisc in the direction indicated by the arrow on the MiniDisc, with the label side facing up. (Insert the MiniDisc firmly, until a click is heard.)
  - The power will be turned on automatically, and playback will start from the first track. (Auto-play function)

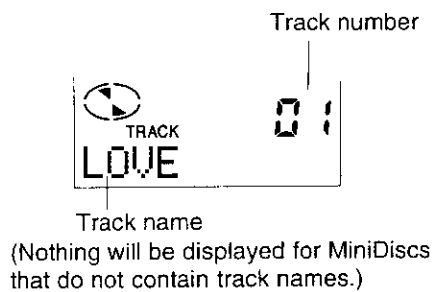

- After playback of the last track has finished, the unit will stop automatically.

## Playback does not start when a MiniDisc is inserted:

Press the **▶||** button.  
In the following cases, the auto-play function will not work.

- When the recordable MiniDisc write protection tab is closed (page 12)
  - When the auto-play function has been canceled (page 38)
- 4** Press the + button to increase the volume and the - button to decrease the volume.

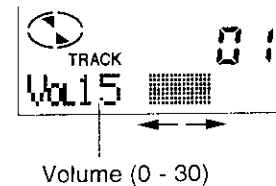

- 5** Adjust the bass level. Each time the BASS/DELETE button is pressed, the tone will be switched as follows:

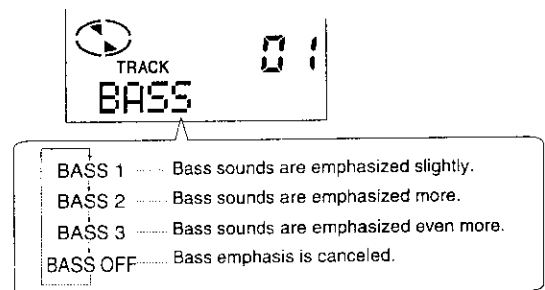

- When recording, it is impossible to adjust the bass level (Bass emphasis is canceled).
- The most recent volume or bass settings are saved when the power is turned off.

**To interrupt playback:**

Press the ►|| button during playback.

- To resume playback, press the ►|| button again.

**To stop playback:**

Press the ■ / OFF button.

- When you press the ►|| button to resume playback, it will start at the point on the disc where playback was halted (Resume function). However, if the MiniDisc is removed and reinserted, playback will start from the first track.

**To turn off the power:**

Press the ■ / OFF button while in the stop mode.

- If the unit is not operated for at least 2 minutes while in the stop mode, the power will be turned off automatically.

**To remove the MiniDisc:**

Turn off the power and move the EJECT lever in the direction indicated by the arrow.

**When using the unit with just the batteries in the battery case:**

- The auto-play function will not work.
- To start playback, hold down the ►|| button for about 1 second.
- Even if a MiniDisc is replaced while the power is turned off, the random or repeat play settings will remain unchanged in memory.

**Precautions when making connections:**

- Do not use any remote control unit, except for the one included with this unit.
- Insert each plug securely, all the way in.
- Be sure to hold the plug when removing it. If you pull on the cord, it may break, or the unit may malfunction.

**Interrupted sound:**

- This product is designed to eliminate interruptions in the sound which can be caused by vibrations. However, if the unit is continuously exposed to vibrations or mechanical shock, the sound may be interrupted momentarily.

**When the sound is distorted:**

- If the volume is too high while the bass is being emphasized, the sound may be distorted, depending on the music on the track. If this happens, decrease the bass level or lower the volume level.

- If the volume is increased to "VOL 26" or higher, the bass level will be adjusted automatically. (This is done to reduce the distortion in the sound.)

**Cautions:**

- When the unit is not to be used immediately after a MiniDisc has been inserted, or when you plan to carry the unit, turn off the power or cancel the auto-play function. Otherwise, the auto-play function will be activated and the batteries will run down.
- Since the main unit and the AC adaptor can heat up during use, you should avoid allowing the unit to be in direct contact with your skin for any length of time.

**When using the unit with a car adaptor:**

- When switching off the ignition during playback, the power to this unit will also be turned off. When the ignition is switched on, playback will start from the beginning of the track where playback was halted (Resume auto-play function). However, the power to the unit may not be turned off when the ignition is turned off, depending on the type of car.

## CONVENIENT PLAYBACK FUNCTIONS

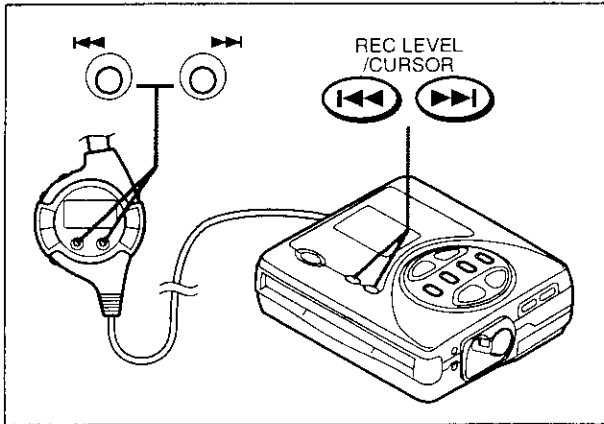

### ■ **APSS** **(Auto Program Search System)**

APSS automatically locates the beginning of any track.

#### **To move to the beginning of the next track:**

Press the ►►► button during playback.

#### **To re-start the track being played:**

Press the ◀◀◀ button during playback.

To skip a number of tracks at one time, press the ◀◀◀ or ►►► button repeatedly until the desired track number is shown.

To begin playback at a desired track, press the ◀◀◀ or ►►► button while in the stop mode to select the track number. Then press the ►|| button.

#### **Note:**

- When the first track is selected and the ◀◀◀ button is pressed, the last track on the disc will be located. When the last track is selected and the ►►► button is pressed, the first track will be located.

### ■ **Cue and review**

- 1 Load a MiniDisc and begin playback.
- 2 Press and hold down the ►►► button for audible fast forward, or press and hold down the ◀◀◀ button for audible fast reverse.
- 3 Normal playback will resume when the ◀◀◀ or ►►► button is released.

#### **Notes:**

- When the end of the last track is reached during fast forward, the unit will enter the pause mode. When the beginning of the first track is reached during fast reverse, the unit will enter the playback mode.
- When the unit is in the all track repeat mode, the search will wrap around from the last track to the first, or vice versa.
- Depending on the contents recorded on a MiniDisc, some sounds may be skipped while cueing and reviewing.

#### **To search very quickly:**

When fast forward or fast reverse is used while in the pause mode, the search will be performed more quickly than during audible fast forward or fast reverse playback.

- In this mode, no sound is heard. Therefore, you should refer to the time display.
- When you lift your finger, the unit will re-enter the pause mode.

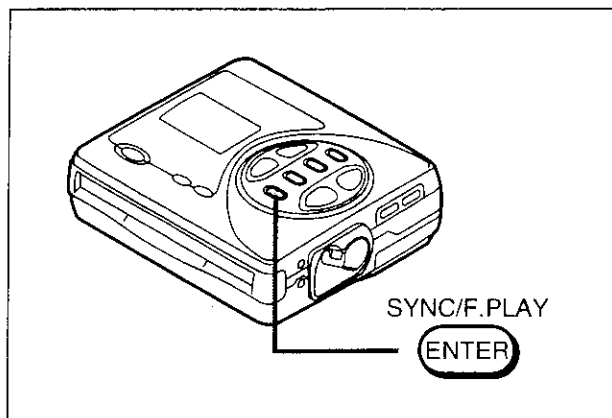

### ■ To play at double speed (Mono recording only)

Press the ENTER/SYNC/F. PLAY button while a MiniDisc recorded in the monaural long-play mode is being played.

- The unit will display "FAST PLAY" and start fast playback.

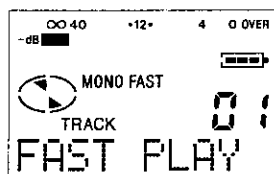

- When the ENTER/SYNC/F. PLAY button is pressed again, the unit will return to normal play.

#### Notes:

- Depending on the contents recorded on a MiniDisc, it may be difficult to hear them.
- If a track recorded in the stereo mode is reached during fast playback, the fast playback mode will be canceled.
- To reenter the fast playback mode, press the ENTER/SYNC/F. PLAY button.

#### To interrupt fast playback:

Press the ►|| button during playback.

- When the ►|| button is pressed again, the unit will resume fast playback.

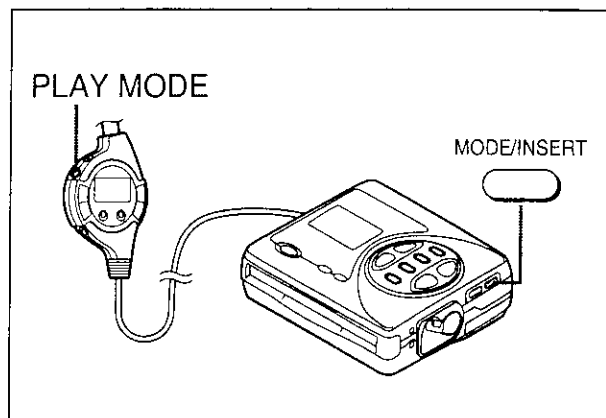

### ■ Random play or repeat play

During playback or while in the stop mode, press the MODE/INSERT button repeatedly to select the playback mode.

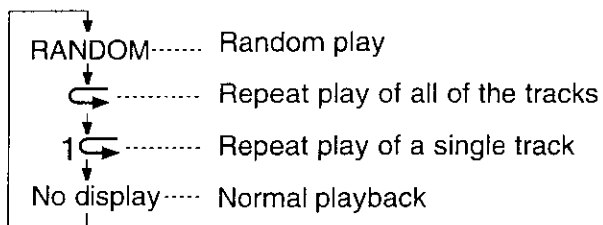

- If the playback mode is selected while stopped, press the ►|| button to start playback.

#### Notes:

- When "TOC" is displayed, repeat play is impossible.
- In random play the unit will select and play tracks automatically. (You cannot select the order of the tracks.) After all of the tracks have been played once each in random order, the unit will stop automatically.
- During random play or repeat play of a single track, cue and review of the previous or next tracks is not possible.
- During random play, the unit cannot find the beginning of any track which has been played.

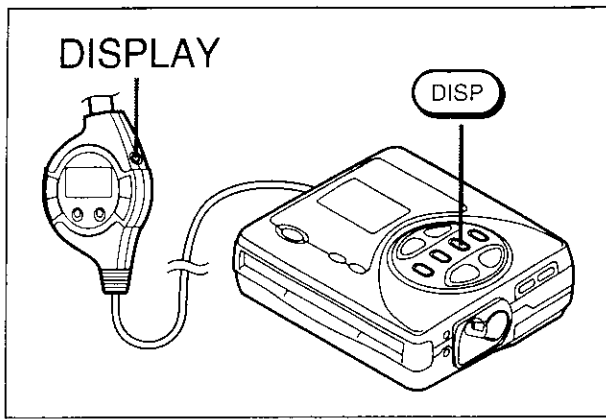

■ **To check the remaining recording time and the total playing time**

While in the stop mode, press the DISP button.

- Each time the button is pressed, the display will change as follows:

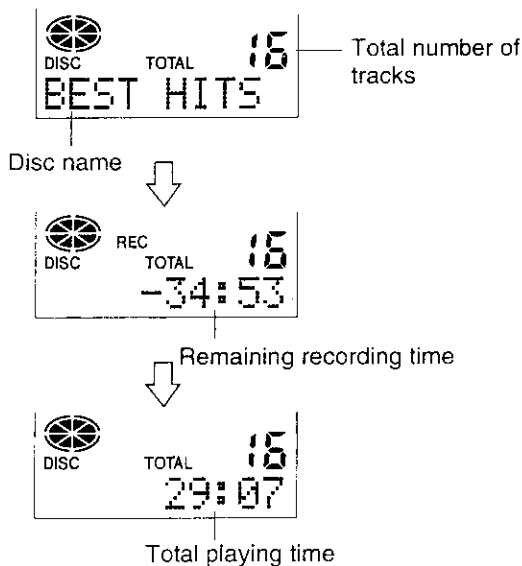

**Note:**

If character information was not originally recorded on the MiniDisc, nothing will be displayed.

■ **To check the elapsed time and remaining time of the track**

During playback, press the DISP button.

- Each time the button is pressed, the display will change as follows:

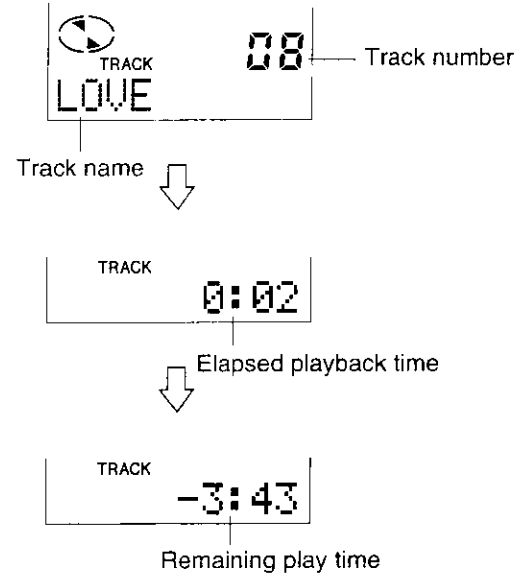

**To check individual track names one by one:**

Press the ◀◀ or ▶▶ button while in the stop mode.

Each time the button is pressed, the name of the previous or next track will be displayed.

**Note:**

- The display of elapsed time during playback may be different from the actual time on a clock.

## ■ What the editing function can do

You can create original discs using the MD editing function, on which you can change the order of the tracks and you can create disc or track names.

- Playback-only MiniDiscs cannot be edited.

### Move (Page 30)

**A designated track can be moved to any desired position.**

- The numbers assigned to the tracks following the track which is moved will be adjusted automatically.

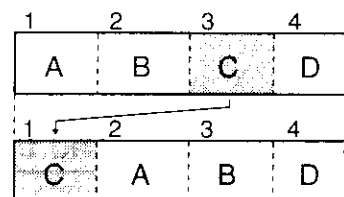

### Divide (Page 30)

**A single track can be divided into two at any desired position.**

- The numbers of the tracks which come after the newly divided track will be automatically increased by one.

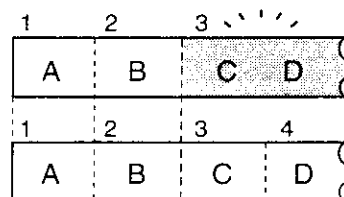

### Combine (Page 31)

**Two consecutive tracks can be combined into one track.**

- The numbers assigned to the tracks following the combined tracks will be decreased by one automatically.

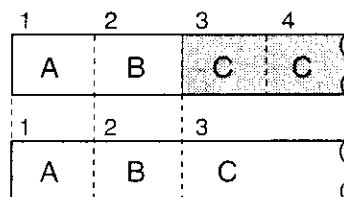

### Disc/Track name (Page 31)

**Discs and tracks (up to 255 tracks per disc) can be named.**

**Since track names are displayed when the beginning of each track is located or during playback, you can quickly check the name of each track.**

- Letters (capital letters/lowercase letters), numbers and symbols can be used.

### Name/stamp (Page 33)

- All of the characters and data on a recorded MD (master MD with tracks and character information) can be transferred onto a recordable MD.

## ■ Move

- 1 Play the track to be moved, and press the ►|| button.
  - The unit will enter the pause mode.
- 2 Press the EDIT/AUTO MARK button to select "MOVE".

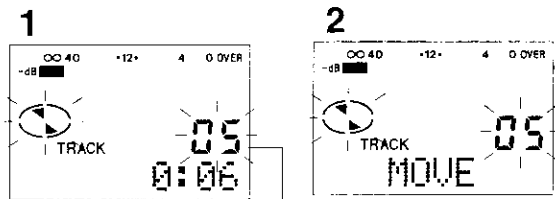

To move the fifth track

- 3 Press the ENTER/SYNC/F.PLAY button.
  - To cancel the operation, press the ■ / OFF button.
- 4 Press the ◀◀ or ▶▶ button to select the direction to move.
  - To increase the track number .... ▶▶
  - To decrease the track number .... ◀◀



(Checking the movement)

(To move it to the third track)

- 5 Press the ENTER/SYNC/F.PLAY button again.
  - The track will be moved, and the unit will be paused at the beginning of the track.

### Note:

- When a track has been moved, the other tracks which are affected by the move will be assigned new track numbers automatically.

**Example:** When moving the fifth track to the third track, the old third track will become the new fourth track and the old fourth track will become the new fifth track.

## ■ Divide

- 1 Start playing the track you want to divide into two. Press the ►|| button at the point where you want to divide the track.
  - The unit will enter the pause mode.
- 2 Press the EDIT/AUTO MARK button to select "DIVIDE".

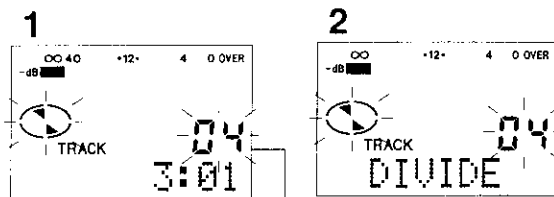

To divide the fourth track

- 3 Press the ENTER/SYNC/F.PLAY button.
  - To cancel the operation, press the ■ / OFF button.



(Confirming the split)

- 4 Press the ENTER/SYNC/F.PLAY button again.
  - The track will be divided into two tracks, and the unit will be paused at the beginning of the second of the two tracks.
  - The numbers of the tracks which come after the divided track will be increased by one automatically.

### Notes:

- When a track that has a name is divided, the two new tracks will have the same name. However, in the TOC FULL condition, the second track may not be named.
- Each disc can hold up to 255 tracks. However, even if the number of assigned tracks has not reached 254, it might not be possible to make any further divisions of tracks.

## ■ Combine

- 1 Start playing the last of the two tracks you want to combine, and press the ►|| button.
  - The unit will enter the pause mode.
- 2 Press the EDIT/AUTO MARK button to select "COMBINE".

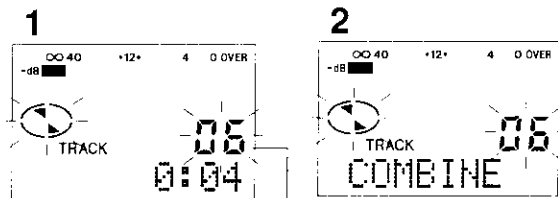

To combine the fifth and sixth tracks

- 3 Press the ENTER/SYNC/F.PLAY button.
  - To cancel the operation, press the ■ / OFF button.

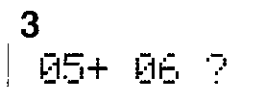

(Confirming the combination)

- 4 Press the ENTER/SYNC/F.PLAY button again.
  - The two tracks will be combined, and the unit will be paused at the beginning of the combined track.
  - The numbers assigned to the tracks following the combined track will be decreased by one automatically.

### To combine two non-contiguous tracks:

First, put the two tracks next to each other in the order you want using the MOVE function (page 30). Then combine them using the COMBINE function.

### When one or both tracks to be combined have a name:

The first track name will be used. However, when the first track does not have a name, the second track name will be used.

### In the following cases, tracks cannot be combined.

- Tracks recorded in the monaural long-play mode and tracks recorded in the stereo mode.
- Tracks recorded from digital inputs and tracks recorded from analog inputs.
- Tracks whose recording time is less than 12 seconds.

## ■ Disc name

- Discs can be named using a maximum of 100 characters.
- Up to 1,700 characters (approximately) can be used in the disc and track names on a single MiniDisc.

- 1 While in the stop mode, press the EDIT/AUTO MARK button to select "DISC NAME".

- 2 Press the ENTER/SYNC/F.PLAY button.

- The unit will enter the character input mode.
- To cancel the operation, press the ■ / OFF button.

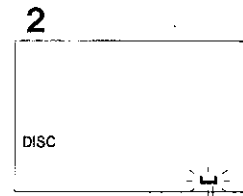
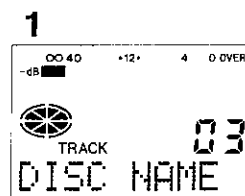

Cursor

- 3 Press the CHARACTER button repeatedly to select the type of characters.

- The first 3 characters in the group of the selected characters will be displayed for about 1 second.

! "# (Symbols)  
↓  
ABC (Capital letters)

- 4 Press the + or - button repeatedly to select the first letter in the name.

- When the button is pressed continuously, the displayed character will change rapidly.





- 5** When the letter you want is displayed, press the ►► button.
- To enter more letters in the name, repeat steps 3 - 5.
- 6** When the disc name has been completely entered, press the ENTER/SYNC/F.PLAY button.



**If an incorrect letter is entered:**

**To erase a character:**

Press the ◀◀ or ▶▶ button to move the cursor to the character you want to erase, and then press the BASS/DELETE button.

**To correct a character:**

Press the ◀◀ or ▶▶ button to move the cursor to the character you want to correct, and then enter the correct character.

- Even after all the letters have been entered, you can still go back and correct any mistakes.

**When you want to enter lowercase letters:**

Enter capital letters as described in step 4 and press the DISP button to change them to the lowercase letters.

If you press this button again, the letters will be changed back to capital letters.

**To enter a space:**

Press the + or - button to select "SPACE". Then, press the ►► button to enter a space.

**■ Track name**

Up to 100 characters can be entered for each name.

- 1 Play the track which you want to name, and press the ►|| button.
  - The unit will enter the pause mode.
- 2 Press the EDIT/AUTO MARK button to select "Tr NAME".
  - When "Tr NAME" is selected while in the stop mode, track numbers can be changed using the ◀◀ or ▶▶ button.

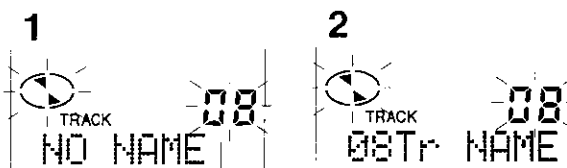

Track number that you want to give a track name

- 3 Press the ENTER/SYNC/F.PLAY button.

- The unit will enter the character input mode.
- To cancel the operation, press the ■ / OFF button.

- 4 Perform steps 3 - 5 in the "Disc name" section.

- 5 When the track name is completely entered, press the ENTER/SYNC/F.PLAY button.

Type of characters	Characters <symbols> (They are selected using the + or - button.)
Capital letters	<div style="display: flex; justify-content: space-between; align-items: center;"> <div style="display: flex; gap: 5px;"> <span>[ ]</span> A B C D E . . . . . V W X Y Z</div> <div style="display: flex; gap: 5px;"> <span>[ ]</span> 0 1 2 3 4 5 . . . . . 8 9           </div> <div style="margin-left: 20px;">→ Returns to [ ] .</div> </div>
Symbols	<div style="display: flex; justify-content: space-between; align-items: center;"> <div style="display: flex; gap: 5px;"> <span>[ ]</span> / ' _ , - + : ( ) &amp; &lt; &gt;           </div> <div style="display: flex; gap: 5px;"> <span>[ ]</span> ! ? ; " # \$ % * = @ _ [ ]           </div> <div style="margin-left: 20px;">→ Returns to [ ] .</div> </div>

[ ] indicates a space.

## ■ To change track names or disc names

Some MiniDiscs created on other equipment may have more than 100 characters in a track name or disc name. The characters from the 101st character and on cannot be corrected or changed.

### To change characters:

- 1 Put the unit in the character input mode.
  - To change characters in a disc name, perform steps 1 - 2 on page 31.
  - To change characters in a track name, perform steps 1 - 3 on page 32.
- 2 Press the **◀◀** or **▶▶** button to move the cursor to the character you want to change.
- 3 Enter the new character you want, and press the **ENTER/SYNC/F.PLAY** button.

### To delete characters:

- 1 Put the unit in the character input mode.
  - To delete characters in a disc name, perform steps 1 - 2 on page 31.
  - To delete characters in a track name, perform steps 1 - 3 on page 32.
- 2 Press the **◀◀** or **▶▶** button to move the cursor to the character you want to delete.
- 3 Press the **BASS/DELETE** button.
  - The character will be erased.
- 4 Press the **ENTER/SYNC/F.PLAY** button.

## To add characters:

- 1 Put the unit in the character input mode.
  - To add characters to a disc name, perform steps 1 - 2 on page 31.
  - To add characters to a track name, perform steps 1 - 3 on page 32.
- 2 Press the **◀◀** or **▶▶** button to move the cursor to the right of the character, where you want to add a new character.
- 3 Press the **MODE/INSERT** button.
  - A space will be inserted.
- 4 Enter the new character you want, and press the **ENTER/SYNC/F.PLAY** button.

## ■ Name/stamp

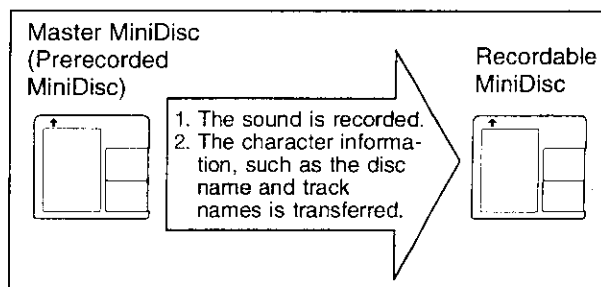

- 1 Record the sound from the master MiniDisc onto a recordable MiniDisc.

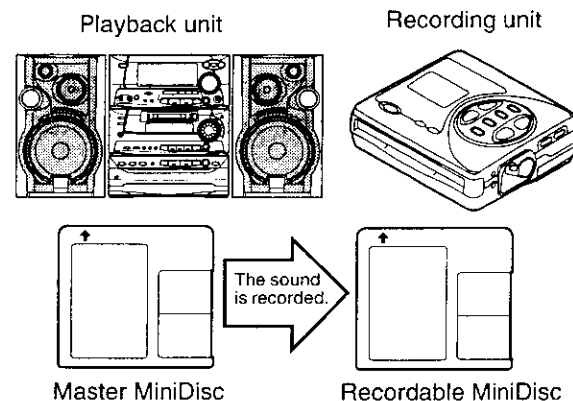

- Refer to the standard recording method. (Pages 11 to 15)
- At this point, only the sound is recorded. No character information is transferred.

- Check whether the total number of tracks on the newly recorded MiniDisc matches the total number of tracks on the master MiniDisc. If they do not match each other, combine or divide tracks using the edit operation. (Pages 30-31)
  - This function can not be performed from pre-recorded (playback only) MiniDiscs.
- 2 When the recording is complete, remove the newly recorded MiniDisc and load the master MiniDisc into the DMC-J7R.
    - Do not mistake the master MiniDisc for the newly recorded MiniDisc.
  - 3 While in the stop mode, press the EDIT/AUTO MARK button to select "NAME STAMP".
  - 4 Press the ENTER/SYNC/F.PLAY button.
    - To cancel the operation, press the ■ / OFF button.

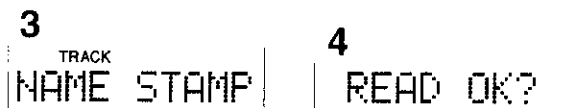

- 5 Press the ENTER/SYNC/F.PLAY button.
  - The character information of the master MiniDisc is being read.
- 6 When the unit displays "CHANGE MD", remove the master MiniDisc.
  - Remove the master MiniDisc without turning off the power. If you do, the operation will be canceled.



- 7 Load the newly recorded MiniDisc into the DMC-J7R.
  - To cancel the operation, press the ■ / OFF button.

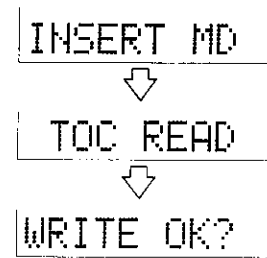

- 8 Press the ENTER/SYNC/F.PLAY button.
  - The unit will finish recording the character information and enter the stop mode.



**Note:**

- If the total number of tracks on the master MiniDisc does not match the total number of tracks on the newly recorded MiniDisc, the unit will display "Can't WRITE" and the power will be turned off. If this happens, adjust the total number of tracks on the newly recorded MiniDisc using the edit operation, and then try again from step 2.

## USING WITH OTHER EQUIPMENT

- Before connecting any other equipment, turn off the power to all units.
- Connect the plugs securely.  
Improper connections may cause noise or malfunctions.

### ■ Listening through a stereo or a radio cassette player or recording on a cassette tape

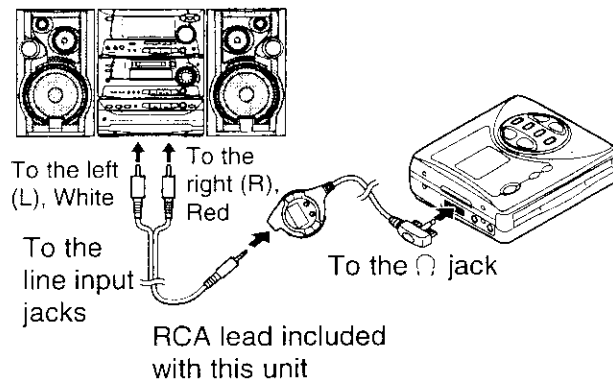

- The recording will be made in the analog mode.
- When you want to listen to a disc using a separate stereo system or radio cassette player, it is recommended that you adjust the volume on the MiniDisc unit to maximum.

### ■ Listening through a car stereo

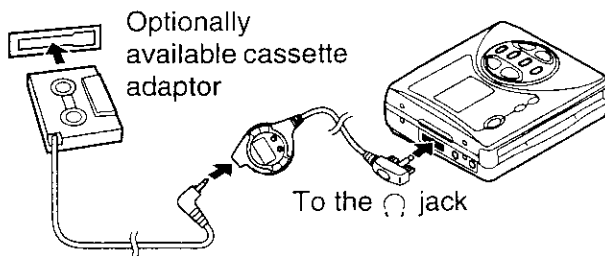

- The optionally available cassette adaptor may not work, depending on your car's stereo.

**Note:**

- The cassette adaptor is only sold in certain areas. For more details, please ask your dealer.

### ■ Listening through commercially available headphones

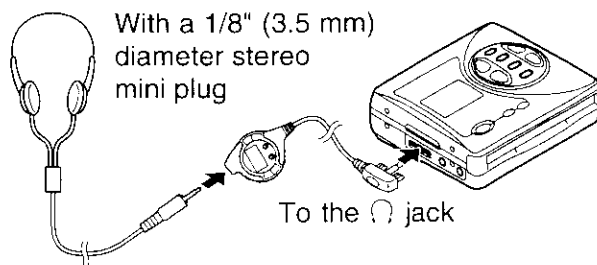

- The battery life may be different, depending on the impedance of the headphones used.
- Headphones can be connected directly to the main unit.

# CONVENIENT OPERATION FEATURES

## ■ Checking the remaining amount of battery charge

The remaining amount of battery charge is shown by the battery indicator (  ) during operation.

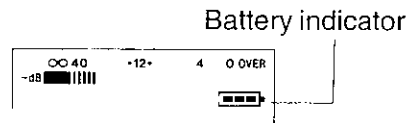

### < How to read the battery indicator >

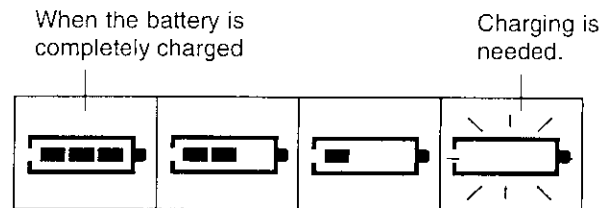

When the battery needs charging, it is impossible to start recording or editing.

- When the battery is completely discharged, the whole battery indicator will flash. Recharge the battery or replace the alkaline batteries with new ones.
- When the battery has completely run out, "BATT EMPTY" (main unit) and "Lo BATT" (remote control unit) will appear. The power will be disconnected automatically.

### Notes:

- When the AC adaptor included with this unit or an optionally available car adaptor is used, the battery indicator will not be shown.
- The number of bars shown in the battery indicator may increase or decrease, depending on the operation being performed. This is normal.
- When the rechargeable battery and the alkaline batteries are used at the same time, the rechargeable battery is used first, and then the alkaline batteries. Since the battery indicator shows the remaining amount of the particular battery being used, the number of bars will increase when the unit switches to the alkaline batteries.

## ■ To prevent the unit from being operated by mistake

To prevent accidental operation, use the hold function.

Move the HOLD switch to the safety position (direction indicated by the arrow).

- When the unit is in the "hold" mode, pressing the buttons will have no effect.

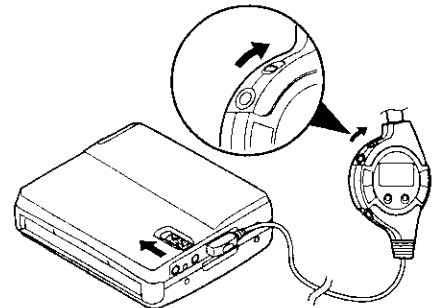

- To cancel the hold mode, move the HOLD switch away from the safety position (the opposite direction of the arrow).

	Remote control unit	Main unit
Can be operated from either the remote control unit or the main unit.	Cancel	Cancel
Can only be operated from the remote control unit.	Cancel	Hold
Can only be operated from the main unit.	Hold	Cancel
Cannot be operated from either the remote control unit or the main unit.	Hold	Hold

If the hold function is active while the power is turned off, the power cannot be turned on by mistake and the battery will not be accidentally drained.

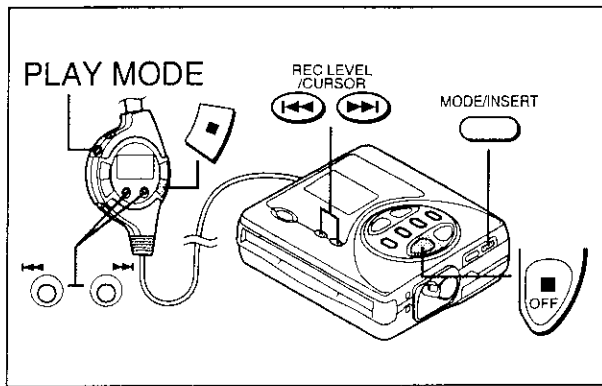

**■ To eliminate the confirmation sound**

Every time a button is pressed, a “beep” will be heard in the headphones. To silence the “beep” sound, do the following:

- 1 While in the stop mode ...**  
Hold down the PLAY MODE button or the MODE/INSERT button until “SET UP” appears.
  - When you release the button, “BEEP 1 (BEEP ON)” will appear.
- 2** Press the PLAY MODE button or the MODE/INSERT button.
  - “BEEP 0 (BEEP OFF)” will appear, and the confirmation sound will disappear.
  - To restore the confirmation sound, select “BEEP 1 (BEEP ON)”.
- 3** Press the ■ / OFF button.
  - The normal display will reappear.

**■ To turn off the display backlight**

Whenever you press a button, the display will light for about 4 seconds, so that you can read it in the dark. You can turn off the backlight.

- 1 While in the stop mode ...**  
Hold down the PLAY MODE button or the MODE/INSERT button until “SET UP” appears.
  - When you release the button, “BEEP 1 (BEEP ON)” or “BEEP 0 (BEEP OFF)” will appear.
- 2** Hold down the ◀◀ or ▶▶ button until “EL on (EL ON)” appears.
- 3** Press the PLAY MODE button or the MODE/INSERT button.
  - “EL off (EL OFF)” will appear, and the backlight will go out.
  - To turn the backlight back on, select “EL on (EL ON)”.
- 4** Press the ■ / OFF button.
  - The normal display will reappear.

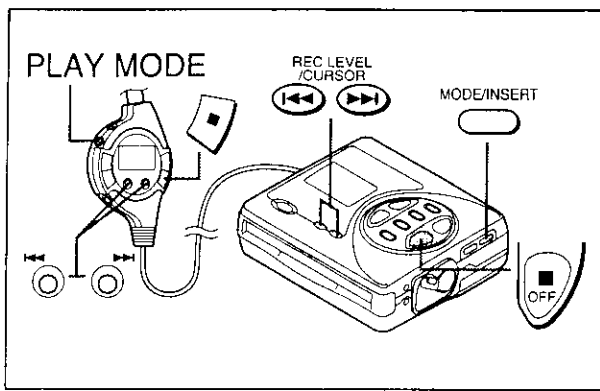

## ■ To cancel the auto-play function

When a MiniDisc is inserted, the power will be turned on and playback will begin automatically. You can cancel automatic playback.

- 1** While in the stop mode ...  
Hold down the PLAY MODE button or the MODE/INSERT button until "SET UP" appears.
  - When you release the button, "BEEP 1 (BEEP ON)" or "BEEP 0 (BEEP OFF)" will appear.
- 2** Press the ◀◀ or ▶▶ button until "auto PL (A-PLAY ON)" appears.
- 3** Press the PLAY MODE button or the MODE/INSERT button.
  - "PL off (A-PLAY OFF)" will appear, and the auto-play function will be canceled.
  - To restore the auto-play function, select "auto PL (A-PLAY ON)".
- 4** Press the ■ / OFF button.
  - The normal display will reappear.

## ■ To cancel the auto power save function

Power consumption can be reduced by changing the anti shock memory storage time. The auto power save function can be canceled for maximum anti shock memory.

- 1** While in the stop mode ...  
Hold down the PLAY MODE button or the MODE/INSERT button until "SET UP" appears.
  - When you release the button, "BEEP 1 (BEEP ON)" or "BEEP 0 (BEEP OFF)" will appear.
- 2** Press the ◀◀ or ▶▶ button until the "auto PS (AUTO Psave)" appears.
- 3** Press the PLAY MODE button or the MODE/INSERT button.
  - "PS off (Psave OFF)" will appear, and the auto power save function will be canceled.
  - To restore the auto power save function, select "auto PS (AUTO Psave)".
- 4** Press the ■ / OFF button.
  - The normal display will reappear.

### **About the sound skip guard memory:**

During playback, approximately 10 seconds of information is stored in the semiconductor memory. Therefore, even when the pickup cannot read information for a second or two due to an external shock, the sound will continue without interruption because the information stored in memory is used.

### **About the auto power save function:**

This is a function used to save power when using the unit with the rechargeable battery or the alkaline batteries. While in the auto power save mode, 5 - 10 seconds of sound information is stored in memory. When the unit is used in places exposed to excessive vibration, cancel the auto power save function. When the auto power save function is disabled, 10 seconds of sound information is always stored in memory. (When the AC adaptor or a car adaptor is used, the information storage time is always 10 seconds, regardless of the auto power save mode.)

## WHAT IS A MINIDISC?

A MiniDisc is a disc inside a protective cartridge. You can handle it freely without worrying about dust, fingerprints, etc. However, if dust enters the opening of the cartridge, or there is excessive dirt on the cartridge, or the cartridge becomes warped, you may experience malfunctions. Please note the following.

### ■ Handling the MiniDisc

#### **Do not touch the disc directly!**

Do not open the shutter or touch the disc directly.

If the shutter is forced open, it may break.

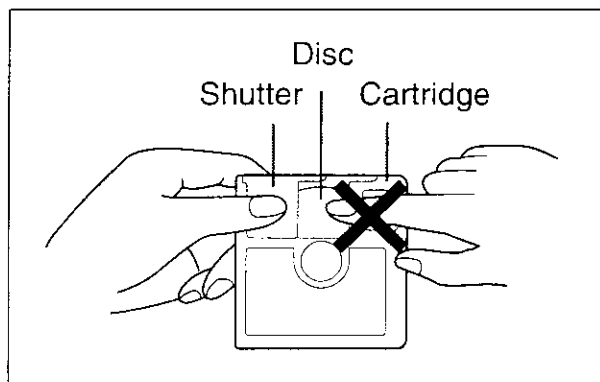

- Never disassemble a MiniDisc.

### ■ Where not to store discs

Do not store discs in places with high temperatures or humidity. Specifically, do not leave discs in places exposed to direct sunlight or in cars with the doors and windows closed.

Do not leave discs in places where sand can get into the cartridge easily (e.g., beaches).

### ■ Helpful tip when attaching a label

When attaching a label to an MD cartridge, be sure to note the following. If the label is not attached properly, the MiniDisc may jam inside the unit and it may not be possible to remove it.

- If the label peels off or partially lifts away, replace it with a new one.
- Do not put a new label on top of an existing one.
- Attach the label only in the specified location. (If it is not within the specified area, it may cause the disc to jam in the unit.)

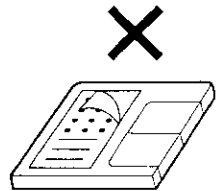

### ■ Regular cleaning

If the surface of the cartridge becomes dusty or dirty, clean it with a dry cloth.

## TROUBLESHOOTING

### ■ Moisture condensation

In the following cases, condensation may form inside the unit.

- Shortly after turning on a heater.
- When the unit is placed in a room where there is excessive steam or moisture.
- When the unit is moved from a cool place to a warm place.

**When the unit has condensation inside, the disc signals cannot be read, and the unit may not function properly.**

- If this happens, remove the disc. The condensation should evaporate in approximately 1 hour. The unit will then function properly.



Many potential “problems” can be resolved by the owner without calling a service technician. If something seems to be wrong with this product, check the following before calling your authorized KENWOOD dealer or service center.

PROBLEM	CAUSE
<b>The unit does not turn on.</b>	<ul style="list-style-type: none"> <li>● Is the AC adaptor disconnected?</li> <li>● Is the battery exhausted?</li> <li>● Is the unit in the safety mode?</li> <li>● Has condensation formed inside the unit?</li> <li>● Is the unit being influenced by mechanical shock or by static electricity?</li> </ul>
<b>No sound is heard from the headphones.</b>	<ul style="list-style-type: none"> <li>● Is the volume set too low?</li> <li>● Is the remote control unit or the headphones plugged in?</li> <li>● Are you trying to play a MiniDisc with data on it instead of a MiniDisc containing music?</li> </ul>
<b>When the operation buttons are pressed, the unit does not respond.</b>	<ul style="list-style-type: none"> <li>● Is the unit in the safety mode?</li> <li>● Is the battery exhausted?</li> <li>● Is the remote control unit plug or the headphone plug inserted firmly?</li> </ul>
<b>Some sounds are skipped.</b>	<ul style="list-style-type: none"> <li>● Is the battery exhausted?</li> <li>● Is the unit being subjected to excessive vibration?</li> </ul>
<b>The MiniDisc cannot be ejected.</b>	<ul style="list-style-type: none"> <li>● Has the track number or character information been written on the disc yet?</li> <li>● Is the unit in the recording or editing mode?</li> </ul>
<b>Recording and editing are impossible.</b>	<ul style="list-style-type: none"> <li>● Is the MiniDisc protected against accidental erasure?</li> <li>● Is the unit connected properly to the other equipment?</li> <li>● Is the AC adaptor unplugged or did a power failure occur while recording or editing?</li> <li>● Is the unit in the safety mode?</li> </ul>

### ■ If trouble occurs

When this product is subjected to strong external interference (mechanical shock, excessive static electricity, abnormal supply voltage due to lightning, etc.) or if it is operated incorrectly, it may malfunction. If such a problem occurs, do the following:

1. Unplug the AC adaptor from the AC outlet.
2. Remove the battery.
3. Leave the unit completely unpowered for approximately 30 seconds.

4. Plug the AC adaptor back into the AC outlet and retry the operation.

If strange sounds, smell or smoke come out of the unit or an object is dropped into the unit, remove the AC adaptor from the AC outlet immediately and contact an authorized KENWOOD service center.

## MINIDISC SYSTEM LIMITATIONS

MiniDiscs are recorded using a different system than is used for cassette tapes or DAT recordings. Therefore, the following conditions may be encountered, depending on how the disc has been recorded or edited. These are due to system limitations, and should be considered normal.

<p><b>Even if the maximum recording time of a MiniDisc has not been reached, "DISC FULL" or "TOC FULL" may be displayed.</b></p>	<p>When the number of tracks used reaches the limit, regardless of the remaining recording time, further recording will be impossible. (Maximum number of tracks: 254) If a MiniDisc has been recorded or edited repeatedly or if a MiniDisc has scratches on it, it may not be possible to record the maximum number of tracks on it.</p>
<p><b>Even if the number of tracks and the recording time have not reached the limit, "DISC FULL" may be displayed.</b></p>	<p>If there are scratches on a disc, the unit will automatically avoid recording in those areas. The recording time will be reduced.</p>
<p><b>Even if several short tracks are erased, the remaining recording time may not show an increase.</b></p>	<p>When the remaining recording time of a disc is displayed, short tracks less than 8 seconds long may not be included in the total.</p>
<p><b>Two tracks may not be combined in editing.</b></p>	<p>For MiniDiscs on which repeated recording and editing operations were performed, the COMBINE function may not work.</p>
<p><b>The total of the recorded time and time remaining on a disc may not add up to the maximum possible recording time.</b></p>	<p>A cluster (about 2 seconds) is normally the minimum unit of recording. So, even if a track is less than 2 seconds long, it will use about 2 seconds of space on the disc. Therefore, the time actually available for recording may be less than the remaining time displayed. If there are scratches on discs, those sections will be automatically avoided (no recording will be placed in those sections). Therefore, the recording time will be reduced.</p>
<p><b>When recorded tracks are played back using the cue and review operations, some sounds may be skipped.</b></p>	<p>For MiniDiscs on which repeated recording and editing were performed, some sounds may be skipped while cueing and reviewing.</p>
<p><b>While recording, a track number may be created in the middle of a track.</b></p>	<p>If there are scratches or dust on a MiniDisc, the track numbers following that track will be increased by one.</p>

## ERROR MESSAGES

Error messages	Meaning	Remedy
<b>BATT EMPTY</b>	<ul style="list-style-type: none"> <li>● The battery has run down.</li> </ul>	<ul style="list-style-type: none"> <li>● Charge the rechargeable battery or replace the alkaline batteries (or use the AC adaptor for power).</li> </ul>
<b>BLANK DISC</b>	<ul style="list-style-type: none"> <li>● Nothing is recorded.</li> </ul>	<ul style="list-style-type: none"> <li>● Replace the disc with a recorded disc.</li> </ul>
<b>Can't COPY</b>	<ul style="list-style-type: none"> <li>● No copy can be made because of the SCMS copyright system.</li> </ul>	<ul style="list-style-type: none"> <li>● Record using the analog cable.</li> </ul>
<b>Can't EDIT</b>	<ul style="list-style-type: none"> <li>● A track cannot be edited.</li> </ul>	<ul style="list-style-type: none"> <li>● Change the stop position of the track and then try editing it.</li> </ul>
<b>Can't REC</b>	<ul style="list-style-type: none"> <li>● Recording cannot be performed correctly due to vibration or shock in the unit.</li> </ul>	<ul style="list-style-type: none"> <li>● Re-record or replace it with another recordable disc.</li> </ul>
<b>Can't WRITE</b>	<ul style="list-style-type: none"> <li>● Editing is impossible.</li> </ul>	<ul style="list-style-type: none"> <li>● Check the number of tracks.</li> </ul>
<b>DEFECT</b>	<ul style="list-style-type: none"> <li>● The disc is scratched.</li> </ul>	<ul style="list-style-type: none"> <li>● If the sound you hear is not correct, try recording again.</li> <li>● Replace the disc with another recordable disc.</li> </ul>
<b>Din UNLOCK</b>	<ul style="list-style-type: none"> <li>● Poor connection of the digital cable.</li> </ul>	<ul style="list-style-type: none"> <li>● Connect the digital cable securely.</li> </ul>
<b>DISC ERROR</b>	<ul style="list-style-type: none"> <li>● The disc is damaged.</li> </ul>	<ul style="list-style-type: none"> <li>● Reload the disc or replace it.</li> </ul>
<b>DISC FULL</b>	<ul style="list-style-type: none"> <li>● The disc is out of recording space.</li> </ul>	<ul style="list-style-type: none"> <li>● Replace it with another recordable disc.</li> </ul>
<b>HOLD</b>	<ul style="list-style-type: none"> <li>● The unit is in the safety mode.</li> </ul>	<ul style="list-style-type: none"> <li>● Return the HOLD switch to its original position.</li> </ul>
<b>LOCKED LOCK ERROR</b>	<ul style="list-style-type: none"> <li>● The EJECT lever was moved during recording or editing.</li> </ul>	<ul style="list-style-type: none"> <li>● Turn off the power and remove the MiniDisc.</li> </ul>
<b>NO DISC</b>	<ul style="list-style-type: none"> <li>● A disc has not been loaded.</li> </ul>	<ul style="list-style-type: none"> <li>● Load a disc.</li> </ul>
<b>PB DISC PROTECTED</b>	<ul style="list-style-type: none"> <li>● The disc is write protected.</li> <li>● You tried to record on a playback-only disc.</li> </ul>	<ul style="list-style-type: none"> <li>● Move the write protection knob back to its original position.</li> <li>● Replace it with a recordable disc.</li> </ul>
<b>POWER ?</b>	<ul style="list-style-type: none"> <li>● Improper power is being supplied.</li> </ul>	<ul style="list-style-type: none"> <li>● Use one of the specified power sources.</li> </ul>
<b>SORRY</b>	<ul style="list-style-type: none"> <li>● Since a track number is currently being located or written to, the unit cannot accept your command.</li> </ul>	<ul style="list-style-type: none"> <li>● Wait and then try the operation again.</li> </ul>
<b>SYSTEM ERR</b>	<ul style="list-style-type: none"> <li>● The unit is malfunctioning and will require service.</li> </ul>	<ul style="list-style-type: none"> <li>● For service, contact your local KENWOOD authorized service center.</li> </ul>
<b>TEMP OVER</b>	<ul style="list-style-type: none"> <li>● The temperature is too high.</li> </ul>	<ul style="list-style-type: none"> <li>● Turn off the power, and wait for the unit to cool.</li> </ul>
<b>TOC ERROR</b>	<ul style="list-style-type: none"> <li>● A large portion of the disc has been damaged.</li> </ul>	<ul style="list-style-type: none"> <li>● Replace it with another recorded disc.</li> </ul>
<b>TOC FULL</b>	<ul style="list-style-type: none"> <li>● There is no space left for recording character information (track names, disc names, etc.).</li> </ul>	<ul style="list-style-type: none"> <li>● Replace it with another recordable disc.</li> </ul>
<b>Tr. Protect</b>	<ul style="list-style-type: none"> <li>● The track has been protected from being erased.</li> </ul>	<ul style="list-style-type: none"> <li>● Edit the track with the device on which it was recorded.</li> </ul>
<b>U TOC ERROR</b>	<ul style="list-style-type: none"> <li>● A large portion of the disc has been damaged.</li> <li>● There is an error in the recorded signal.</li> </ul>	<ul style="list-style-type: none"> <li>● Replace it with another recorded disc.</li> <li>● Erase all of the signal errors, and then try recording again.</li> </ul>
<b>? DISC</b>	<ul style="list-style-type: none"> <li>● A disc which contains data other than music was played.</li> <li>● There is an error in the signal from the disc.</li> </ul>	<ul style="list-style-type: none"> <li>● A disc which contains non-music data cannot be played.</li> <li>● Replace it with another recorded disc.</li> </ul>

## MAINTENANCE

### ■ Cleaning

#### When the unit becomes dirty

Clean it with a soft cloth.

When the unit is excessively dirty, use a soft cloth dampened in water.

(External surfaces only)

#### Clean the headphone plug and the RCA lead plug.

This will prevent noise.

#### Notes:

- Do not use chemicals for cleaning (gasoline, paint thinner, etc.) It may affect the quality or color.
- Do not apply oil to the inside of the unit. It may cause malfunctions.

## SPECIFICATIONS

As a part of our policy of continuous improvement, KENWOOD reserves the right to make design and specification changes for product improvement without prior notice. The performance specification figures indicated are nominal values of production units. There may be some deviations from these values in individual units.

### ■ General

<b>Power source:</b>	DC 3.6V (rechargeable lithium-ion battery NB-L10A x 1) DC 5V (AC adaptor) AC 120V, 60 Hz DC 3V:     Optionally available battery case (commmercially available, "AA" size, alkaline battery x 2) DC 4.0V:   Optionally available car adaptor, DC-C70 (for cars with a 12-24V DC negative ground electrical system)
<b>Power consumption:</b>	7 W (AC adaptor)
<b>Output power:</b>	RMS; 20 mW (10 mW + 10 mW) (0.2% T.H.D.)
<b>Charging time:</b>	Approx. 3.0 hours (When using the AC adaptor included with the unit)
<b>Battery life:</b>	

When using the rechargeable battery NB-L10A (fully charged) included with the unit	When using two, commercially available, high capacity, "AA" size, alkaline batteries (in the optionally available battery case)	When using two, commercially available, high capacity, "AA" size batteries with the rechargeable battery (fully charged)
Continuous recording: Approx. 4.5 hours	Continuous recording: Approx. 4 hours	Continuous recording: Approx. 8.5 hours
Continuous play: Approx. 6.5 hours	Continuous play: Approx. 8 hours	Continuous play: Approx. 14.5 hours

#### Note:

- The battery case is only sold in certain areas. For more details, please ask your dealer.

- The continuous recording time is for analog inputs when the volume level is set to "VOL 0".
- The continuous play time shows the value when the volume level is set to "VOL 15".
- The above values are the standard values when the unit is charged and used at an ambient temperature of 68°F (20°C).
- The operating time when using alkaline batteries may be different, depending on the type and manufacturer of the batteries, and on the operating temperature.

**Input sensitivity:**

Recording level	Reference input level	Input impedance
MIC H	0.25 mV	10 k ohms
MIC L	2.5 mV	10 k ohms
LINE	100 mV	20 k ohms

**Output level:**

	Specified output	Maximum output level	Load impedance
Headphones	—	10 mW + 10 mW	32 ohms
LINE	300 mV (-12dB)	—	50 k ohms

**Dimensions:**

Width: 3-7/16" (87.0 mm)

Height: 1-3/16" (29.4 mm)

Depth: 3-7/32" (81.5 mm)

**Weight:**

0.49 lbs. (219 g) with rechargeable battery

**Input jack:**

Line/optical digital, microphone (powered by the main unit)

**Output jack:**

Headphones (impedance: 32 ohms)/  
remote control unit

**■ MiniDisc Recorder**

**Type:**

Portable MiniDisc recorder

**Signal readout:**

Non-contact, 3-beam semi-conductor laser pick-up

**Audio channels:**

Stereo 2 channels/monaural (long-play mode) 1 channel

**Frequency response:**

20 – 20,000 Hz (± 3 dB)

**Rotation speed:**

Approx. 400 – 900 rpm

**Error correction:**

ACIRC (Advanced Cross Interleave Reed-Solomon Code)

**Coding:**

ATRAC (Adaptive TRansformed Acoustic Coding), 24-bit computed type

**Recording method:**

Magnetic modulation overwrite method

**Sampling frequency:**

44.1 kHz (32 kHz and 48 kHz signals are converted to 44.1 kHz, and then recorded.)

**Wow and flutter:**

Unmeasurable (less than ±0.001% W. peak)

# MEMO